

## Projektor LED Modular

Modular LED Floodlight / Reflector LED Modular

### Linha Indaiá · CLF-MP(F)

Indaiá Line / Línea Indaiá



Sistema modular que facilita a manutenção e um conjunto de LED e lente que proporcionam alta uniformidade luminosa e excelente distribuição da luz.

*Modular system that facilitates maintenance and a set of LEDs and lenses that provide high luminous uniformity and excellent light distribution.*

*Sistema modular que facilita el mantenimiento y un conjunto de LEDs y lentes que proporcionan una alta uniformidad luminosa y una excelente distribución lumínica.*



#### Driver Dimerizável 0-10V (opcional)

*Dimmable Driver 0-10V (optional) / Controlador Regulable 0-10V (opcional)*



#### Protetor de Surto 10kA incluso

*10kA Surge Protector included / Protector de sobretensión 10kA incluido*



#### Eficiência luminosa de até 170 lm/w

*Luminous efficiency up to 170 lm/w / Eficiencia luminosa hasta 170 lm/w*

## Aplicações Highlights / Destacar



Indústrias  
*Industries / Industrias*



Aeroportos  
*Airports / Aeropuertos*



Fachadas  
*Fronts / Fachadas*



Condomínios  
*Condominiums / Condominios*



Pedágios  
*Tolls / Peajes*



Estacionamentos  
*Parking Lots / Estacionamientos*



Quadras e Estádios  
*Canchas y Estádios*

**Ambientes Internos e Externos**  
*Indoor and Outdoor Environments / Ambientes interiores y exteriores*

**Ambientes Industriais**  
*Industrial Environments / Ambientes Industriales*

**Produto não recomendado para áreas agressivas/salinas**  
*Product not Recommended for Aggressive - Saline Areas / Producto no Recomendado para Áreas Agressivas - Salinas*



**Sistema modular com fixação versátil**

*Modular system with versatile fixing / Sistema modular con fijación versátil.*

**Normas Standards / Normas**

NBR IEC - 60598-1 / NBR IEC - 60529 / NBR IEC - 62031 / IES LM 80-08 / IES TM 21



1 Módulo  
50W



2 Módulos  
100W



3 Módulos  
150W



4 Módulos  
200W

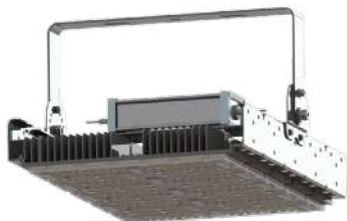

5 Módulos  
250W



6 Módulos  
300W

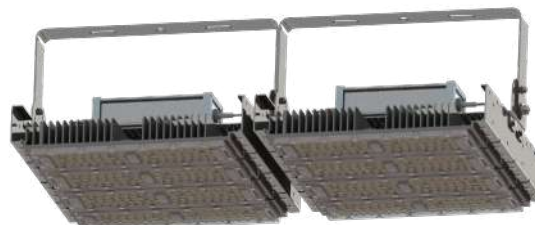

4/4 Módulos  
400W

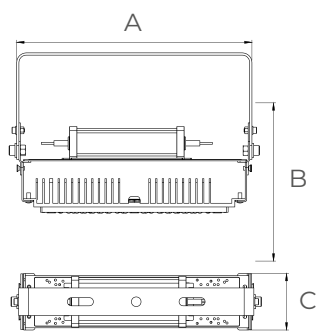

1 Módulo

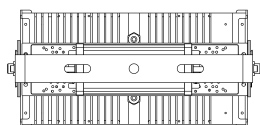

2 Módulos

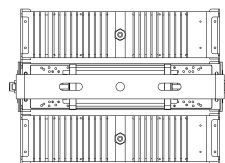

3 Módulos

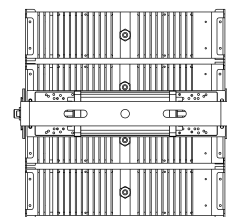

4 Módulos

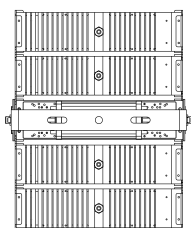
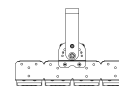
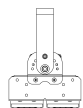

5 Módulos

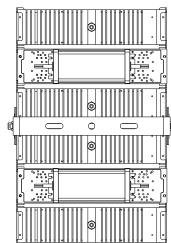

6 Módulos



4/4 Módulos

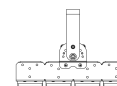
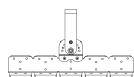

Curvas Fotométricas *Photometric Curves / Curvas Fotométricas*

60°

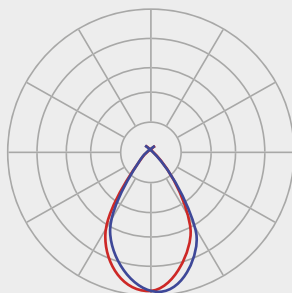

90°

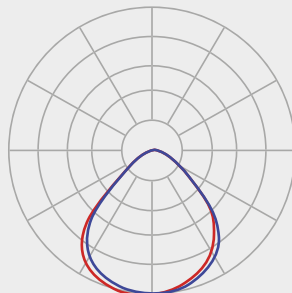

**Informações Técnicas** *Technical Information / Informaciones Técnicas*

<b>Características Gerais</b> <i>General Features / Características Generales</i>	<b>CLF-MP50F</b>	<b>CLF-MP100F</b>	<b>CLF-MP150F</b>	<b>CLF-MP200F</b>	<b>CLF-MP250F</b>	<b>CLF-MP300F</b>	<b>CLF-MP400F</b>
<b>Consumo do Sistema</b> <i>System Consumption / Consumo del Sistema</i>	50W (±10%)	100W (±10%)	150W (±10%)	200W (±10%)	250W (±10%)	300W (±10%)	400W (±10%)
<b>Tensão de trabalho padrão</b> <i>Standard working voltage / Voltaje de trabajo estándar</i>	120-277 VAC						
<b>Frequência de operação</b> <i>Operation Frequency / Frecuencia de Operación</i>	50/60Hz						
<b>Fator de Potência (à plena carga)</b> <i>Power Factor (at full load) / Factor de Potencia (a plena carga)</i>	>0.98 @ 115VAC, >0.95@230VAC						
<b>Condição de Utilização</b> <i>Conditions of Use / Condiciones de Uso</i>	Altitude: 1500m / Temperatura Média do ar: +40°C / Temperatura do ar ambiente: -40°C ~ +60°C / Umidade relativa do ar: até 100%						
<b>Tipo de Proteção elétrica/eletrônica</b> <i>Protection type electrical - electronic / Tipo de protección eléctrica - electrónica</i>	Curto-Circuito, Sobretensão, Sobrecorrente, Sobreaquecimento						
<b>Grau de Proteção</b> <i>Protection Grade / Grado de Protección</i>	IP67						
<b>Grau de Impacto</b> <i>Impact Grade / Grado de Impacto</i>	IK08						
<b>Protetor de Surto</b> <i>Surge Protector / Protetor contra Sobretensiones</i>	UC: 275V - 10Ka (8/20) - 1,0 KV - Categoria C						

<b>Características Fotométricas e Óticas</b> <i>General and Photometric Features / Características Generales y Fotométricas</i>	<b>CLF-MP50F</b>	<b>CLF-MP100F</b>	<b>CLF-MP150F</b>	<b>CLF-MP200F</b>	<b>CLF-MP250F</b>	<b>CLF-MP300F</b>	<b>CLF-MP400F</b>
<b>Índice de Reprodução de Cores</b> <i>Color Rendering Index / Índice de Reproducción de Color</i>	>70						
<b>Temperatura de Cor Padrão</b> <i>Standard Color Temperature / Temperatura de Color Estándar</i>	5 000K (±275K)						
<b>Ângulo do fecho padrão</b> <i>Beam Opening Angle / Ángulo de Apertura del Haz</i>	90°			60°			
<b>Fator de Depreciação Luminosa</b> <i>Light Depreciation Factor / Factor de Depreciación Leve</i>	até 10% para 60 000h @ 1,0A e Tj=65°C						
<b>Vida Útil</b> <i>Estimated Service Life / Vida Estimada</i>	100 000h (L70 B50)						
<b>Fluxo Luminoso da Luminária (@Tj65°C)</b> <i>Luminous Flux of the Fixture / Corrientes de luz de la luminaria</i>	8 500 lm (±10%)	17 000 lm (±10%)	25 500 lm (±10%)	34 000 lm (±10%)	42 500 lm (±10%)	51 000 lm (±10%)	68 000 lm (±10%)
<b>Eficiência da Luminária (@Tj65°C)</b> <i>Luminaire Efficiency / Eficiencia luminaria</i>	170 lm/w (±10%)	170 lm/w (±10%)	170 lm/w (±10%)	170 lm/w (±10%)	170 lm/w (±10%)	170 lm/w (±10%)	170 lm/w (±10%)



Características Construtivas <i>Constructive Features / Características Constructivas</i>	CLF-MP50F	CLF-MP100F	CLF-MP150F	CLF-MP200F	CLF-MP250F	CLF-MP300F	CLF-MP400F
Quantidade de Módulos <i>Number of Modules / Numero de Modulos</i>	1	2	3	4	5	6	8
Material do Corpo <i>Body Material / Cuerpo Material</i>	Alumínio						
Material do Dissipador <i>Heatsink Material / Material del Dissipador de Calor</i>	Alumínio Extrudado 6063						
Material da Lente <i>Lens Material / Material de la Lente</i>	PPMA						
Instalação <i>Installation / Instalación</i>	Fixado através de parafusos e suporte tipo alça						
Peso <i>Weight / Peso</i>	2,1 kg	2,9 kg	3,7 kg	4,5 kg	5,3 kg	7,2 kg	9,1 kg
Medidas (AxBxC) <i>Measures (AxBxC) / Medidas (AxBxC)</i>	316 x 215 x 76mm	316 x 215 x 156mm	316 x 215 x 236mm	316 x 215 x 316mm	316 x 215 x 396mm	316 x 215 x 476mm	632 X 316 X 215mm

## Codificação Codification / Codificación

### CLF



**Linha**  
*Line / Línea*

CLF

### MP50F



**Modelo**  
*Model / Modelo*

MP50F	50W
MP100F	100W
MP150F	150W
MP200F	200W
MP250F	250W
MP300F	300W
MP400F	400W

### K50



**Temp. de Cor**  
*Color Temp. / Temp. del Color*

K50 5000K

### CF60

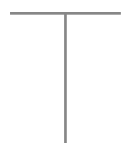

**Tipo de Lente\***  
*Lens Type\* / Tipo de Lente\**

CF60	60°
CF90	90°

### DM



**Dimerizável**  
*Dimmable / Regulable*

### SE



**Acessórios**  
*Accessories / Accesorios*

SE	Suporte para Eletrocalha <i>Cable Tray Support / Soporte de Bandeja de Cables</i>
ST	Suporte para Tubo <i>Tube Support / Soporte para Tubo</i>
PU	Plug 2P+T Universal <i>Universal 2P+T Plug / Enchufe Universal 2P+T</i>
TA	Terminal de Ancoragem <i>Anchorage Terminal / Terminal de Anchorage</i>

\*Lente de 90°: de 50 a 150W - Lente de 60°: de 200 a 400W

\*90° lens: from 50 to 150W - 60° lens: from 200 to 400W / \*Lente 90°: de 50 a 150W - Lente 60°: de 200 a 400W

Consulte-nos: luminárias com alimentação em tensão especial  
(110/220V / 12V / 24V / 125VCC)

Consult us: luminaires with special voltage supply / Consúltenos: luminarias con tensión de alimentación especial