

Luminária LED Blindada Industrial

Industrial Armored LED Luminaire / Luminaria LED Blindada Industrial

Linha Timbó · CLT(D)

Timbó Line / Línea Timbó

20W	30W	45W
60W	80W	90W



A linha Timbó Conexled foi projetada para áreas industriais que requerem proteção as ações do tempo, gases, vapores e pós (TGVP).

The Timbó Conexled line was designed for industrial areas that require protection from the effects of weather, gases, vapors and dust (TGVP).

La línea Timbó Conexled fue diseñada para áreas industriales que requieren protección contra los efectos del clima, gases, vapores y polvo (TGVP).



Difusor Antiofuscamento (jateado)

Anti-glare Diffuser (blasted) / Difusor antideslumbrante (chorreado)



Sistema de Dissipação Eficiente

Efficient Dissipation System / Sistema De Disipación Eficiente



Diversas Opções de Instalação e Aplicação

Various Installation and Application Options / Varias opciones de instalación y aplicación

Aplicações Highlights / Destacar



Ambientes Internos e Externos

Indoor and Outdoor Environments / Ambientes interiores y exteriores

Áreas Agressivas

Aggressive Areas / Áreas Agresivas

*Dependendo da aplicação e área de utilização. Depending on application and area of use. / Dependiendo de la aplicación y el área de uso



Design Compacto e Funcional

Compact and Functional Design / Diseño Compacto Y Funcional

Normas Standards / Normas

NBR IEC - 60598-1 / NBR IEC - 60529
/ NBR IEC - 62031 / IES LM 80-08 / IES TM 21

Corpo 1 *Body 1 / Cuerpo 1*
2D (20W) / 3D (30W) / 5D (45W)

Corpo 2 *Body 2 / Cuerpo 2*
7D (60W) / 9D (80W) / 11D (90W)



Arandela 30°

Wall light 30° / Aplique de pared 30°



Arandela 90°

Wall light 90° / Aplique de pared 90°



Pendente

Pendant / Pendiente



Plafonier

Ceiling light / Lámpara de techo



Suporte para poste 30°

Support for post 30° / Soporte para poste 30°



Suporte para poste 90°

Support for post 90° / Soporte para poste 90°



Alça de fixação

Fixing strap / Correa de fijación

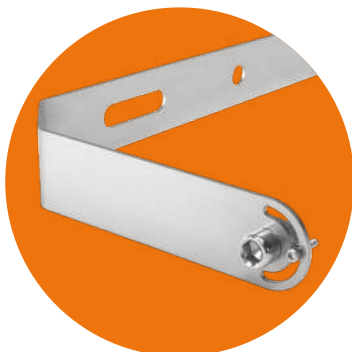

Alça e Parafusos em Inox 304 fornecidos como padrão

304 Stainless Steel Handle and Screws supplied as standard / Manija y Tornillos de Acero Inoxidable 304 suministrados como estándar



Curvas Fotométricas *Photometric Curves / Curvas Fotométricas*

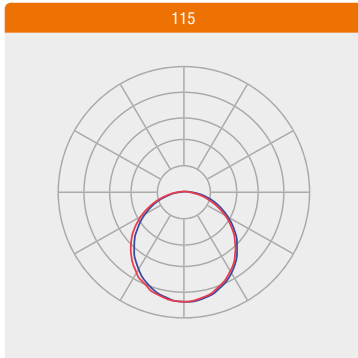

CLT-PDT

Fornecimento padrão com 1 entrada 3/4 NPT

Standard supply with 1 port 3/4 NPT / Suministro estándar con 1 puerto 3/4 NPT

Corpo 1
Body 1 / Cuerpo 1

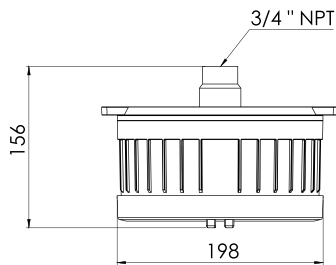

Corpo 2
Body 2 / Cuerpo 2

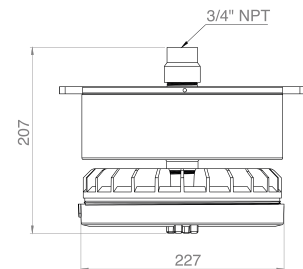

CLT-A30

Fornecimento padrão com 4 entradas 3/4" NPT - 3 com bujão e 1 entrada aberta

Standard delivery with 4 3/4" NPT ports - 3 with plug and 1 open port / Entrega estándar con 4 puertos NPT de 3/4" - 3 con tapón y 1 puerto abierto

Corpo 1
Body 1 / Cuerpo 1

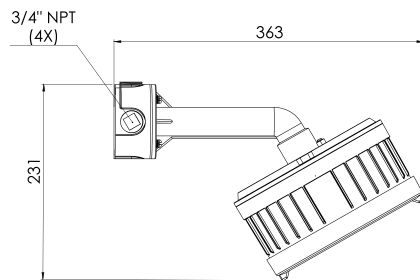

Corpo 2
Body 2 / Cuerpo 2

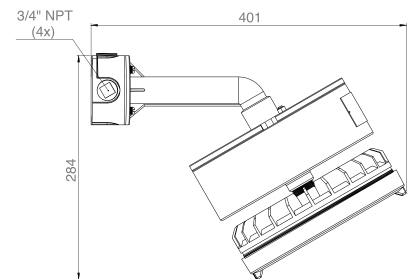

CLT-A90

Fornecimento padrão com 4 entradas 3/4" NPT - 3 com bujão e 1 entrada aberta

Standard delivery with 4 3/4" NPT ports - 3 with plug and 1 open port / Entrega estándar con 4 puertos NPT de 3/4" - 3 con tapón y 1 puerto abierto

Corpo 1
Body 1 / Cuerpo 1

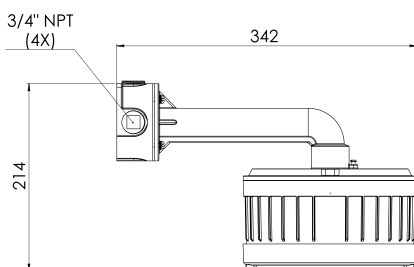

Corpo 2
Body 2 / Cuerpo 2

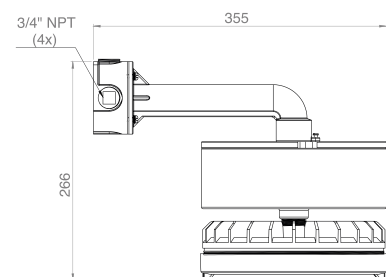



CLT-PLF

Fornecimento padrão com 4 entradas 3/4" NPT - 3 com bujão e 1 entrada aberta

Standard delivery with 4 3/4" NPT ports - 3 with plug and 1 open port / Entrega estándar con 4 puertos NPT de 3/4" - 3 con tapón y 1 puerto abierto

Corpo 1
Body 1 / Cuerpo 1

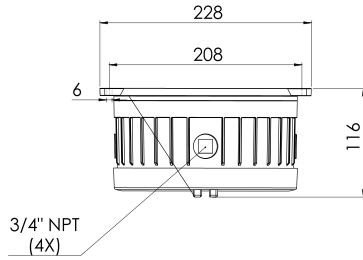

Corpo 2
Body 2 / Cuerpo 2

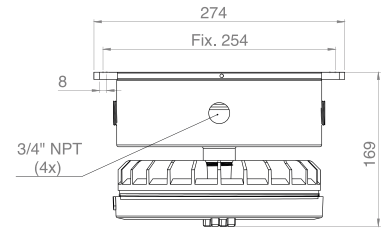

CLT-SP3

Fornecimento padrão com entrada 1.1/2" BSP

Standard delivery with 1.1/2" BSP port / Entrega estándar con puerto BSP de 1,1/2"

Corpo 1
Body 1 / Cuerpo 1

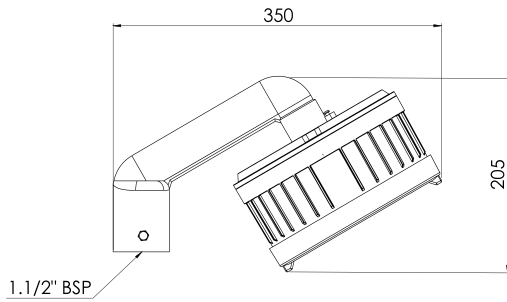

Corpo 2
Body 2 / Cuerpo 2

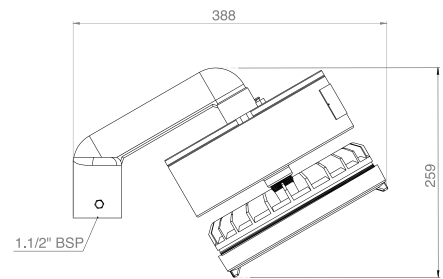

CLT-SP9

Fornecimento padrão com entrada 1.1/2" BSP

Standard delivery with 1.1/2" BSP port / Entrega estándar con puerto BSP de 1,1/2"

Corpo 1
Body 1 / Cuerpo 1

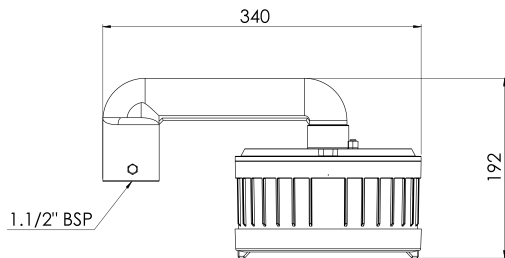

Corpo 2
Body 2 / Cuerpo 2

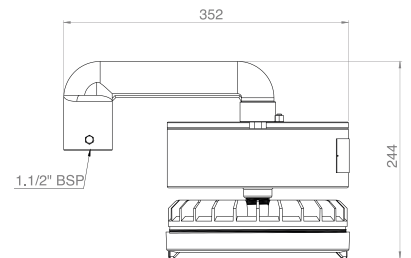

CLT-ALC

Fornecimento padrão com 4 entradas 3/4" NPT - 3 com bujão e 1 entrada aberta

Standard delivery with 4 3/4" NPT ports - 3 with plug and 1 open port / Entrega estándar con 4 puertos NPT de 3/4" - 3 con tapón y 1 puerto abierto

Corpo 1
Body 1 / Cuerpo 1

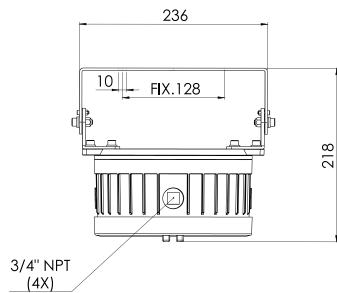

Corpo 2
Body 2 / Cuerpo 2

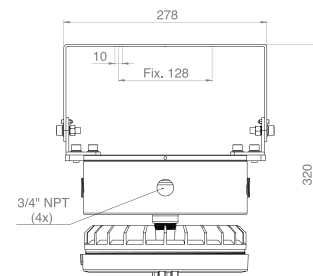

Informações Técnicas *Technical Information / Informaciones Técnicas*

Características Gerais <i>General Features / Características Generales</i>	CLT-PDT / CLT-A30 / CLT-A90 / CLT-PLF / CLT-SP3 / CLT-SP9 / CLT-ALC					
	2D	3D	5D	7D	9D	11D
Consumo do Sistema <i>System Consumption / Consumo del Sistema</i>	20W (±10%)	30W (±10%)	45W (±10%)	60W (±10%)	80W (±10%)	90W (±10%)
Tensão de trabalho padrão <i>Standard working voltage / Voltaje de trabajo estándar</i>	220-240 VAC / 90-305 VAC / 100-280 VCC					
Frequência de operação <i>Operation Frequency / Frecuencia de Operación</i>	50/60Hz					
Fator de Potência (à plena carga) <i>Power Factor (at full load) / Factor de Potencia (a plena carga)</i>	>0.98 @ 115VAC, >0.95@230VAC >0.93@277VAC					
Condição de Utilização <i>Conditions of Use / Condiciones de Uso</i>	Altitude: 1500m / Temperatura Média do ar: +40°C / Temperatura do ar ambiente: -40°C ~ +60°C / Umidade relativa do ar: até 100%					
Tipo de Proteção elétrica/eletrônica <i>Protection type electrical - electronic / Tipo de protección eléctrica - electrónica</i>	Curto-Circuito, Sobretensão, Sobrecorrente, Sobreaquecimento					
Grau de Proteção <i>Protection Grade / Grado de Protección</i>	IP66					
Grau de Impacto <i>Impact Grade / Grado de Impacto</i>	IK08					
Protetor de Surto <i>Surge Protector / Protector contra Sobretensiones</i>	DPS 10kA					

Características Fotométricas e Óticas <i>General and Photometric Features / Características Generales y Fotométricas</i>	CLT-PDT / CLT-A30 / CLT-A90 / CLT-PLF / CLT-SP3 / CLT-SP9 / CLT-ALC					
	2D	3D	5D	7D	9D	11D
Índice de Reprodução de Cores <i>Color Rendering Index / Índice de Reproducción de Color</i>	>80					
Temperatura de Cor Padrão <i>Standard Color Temperature / Temperatura de Color Estándar</i>	5 000K (±275K)					
Ângulo do fecho padrão <i>Beam Opening Angle / Ángulo de Apertura del Haz</i>	115°					
Fator de Depreciação Luminosa <i>Light Depreciation Factor / Factor de Depreciación Leve</i>	até 10% para 50 000h @ 1,0A e Tj=85°C					
Vida Útil <i>Estimated Service Life / Vida Estimada</i>	100 000h (L70 B50)					
Fluxo Luminoso da Luminária (@Tj65°C) <i>Luminous Flux of the Fixture / Corrientes de luz de la luminaria</i>	3 220 (±10%)	4 150lm (±10%)	6 122lm (±10%)	8 100lm (±10%)	9 940lm (±10%)	11 350lm (±10%)
Eficiência da Luminária (@Tj65°C) <i>Luminaire Efficiency / Eficiencia luminaria</i>	139lm/w (±10%)	131lm/w (±10%)	143lm/w (±10%)	135lm/w (±10%)	127lm/w (±10%)	123lm/w (±10%)

Características Construtivas <i>Constructive Features / Características Constructivas</i>	CLT-PDT / CLT-A30 / CLT-A90 / CLT-PLF / CLT-SP3 / CLT-SP9 / CLT-ALC					
	2D	3D	5D	7D	9D	11D
Material do Corpo <i>Body Material / Cuerpo Material</i>	Alumínio Fundido					
Material do Visor <i>Display Material / Material de Exhibición</i>	Padrão: Vidro temperado de 4mm (antiofuscante) / Opcional: Policarbonato 4mm					
Entrada Rosqueada <i>Threaded Entry / Entrada Roscada</i>	Padrão: 3/4" NPT / Opcional: 3/4"BSP ou M25					



Medidas <i>Measures / Medidas</i>	CLT-PDT	CLT-A30	CLT-A90	CLT-PLF	CLT-SP3	CLT-SP9	CLT-ALC
Tamanho Corpo 1 <i>Body Size 1 / Tamaño del Cuerpo 1</i>	198x156mm	363x231mm	342x214mm	228x116mm	350x205mm	340x192mm	236x218mm
Tamanho Corpo 2 <i>Body Size 2 / Tamaño del Cuerpo 2</i>	227x207mm	401x284mm	355x266mm	274x169mm	388x259mm	352x243mm	320x278mm
Peso Corpo 1 <i>Body Weight 1 / Peso Cuerpo 1</i>	2,8Kg	3,5Kg	3,5Kg	2,8Kg	3,8Kg	3,8Kg	3,1Kg
Peso Corpo 2 <i>Body Weight 2 / Peso Cuerpo 2</i>	4,9Kg	5,6Kg	5,6Kg	4,9Kg	5,9Kg	5,9Kg	5,2Kg
Instalação <i>Installation / Instalación</i>	Fixado Pendente <i>Fixed Pending / Pendiente Fija</i>	Arandela 30° <i>Sconce 30° / Candelabro de Pared 30°</i>	Arandela 90° <i>Sconce 90° / Candelabro de Pared 90°</i>	Plafonier <i>Ceiling Light / Lámpara de Techo</i>	Poste 30° <i>Pole 30° / Poste 30°</i>	Poste 90° <i>Pole 90° / Poste 90°</i>	Alça <i>Strap / Bandolera</i>

Comparativo LED X Convencional <i>Comparative LEDXConventional / Comparativo LEDXConvencional</i>	CLT-PDT / CLT-A30 / CLT-A90 / CLT-PLF / CLT-SP3 / CLT-SP9 / CLT-ALC					
	2D	3D	5D	7D	9D	11D
Equivalência <i>Equivalence / Equivalencia</i>	HID 50W	HID 70W	HID 100W	HID 150W	HID 200W	HID 250W

Codificação *Codification / Codificación*

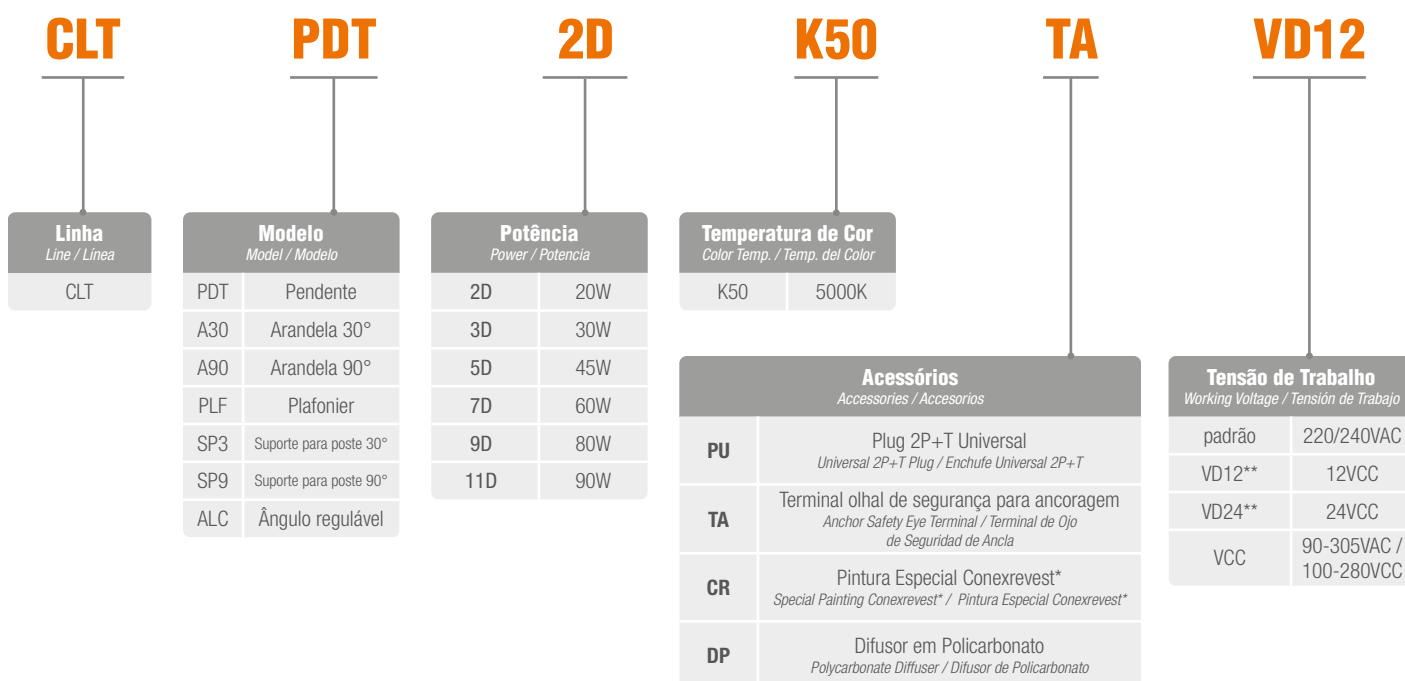

*3 Anos de Garantia na Condição CR

**3 Years Warranty in CR Condition / *3 Años de Garantía en Condición CR*

**Tensões de Trabalho 440VAC, 12VCC e 24VCC disponíveis sob encomenda.

Working voltages 440VAC, 12VDC and 24VDC available on request. / Voltajes de trabajo 440VAC, 12VDC y 24VDC disponibles bajo pedido.

Consulte-nos: luminárias com alimentação em tensão especial
(110/220V / 12V / 24V / 125VCC)

Consult us: luminaires with special voltage supply / Consúltenos: luminarias con tensión de alimentación especial