

Luminária LED para Atmosferas Explosivas com Alojamento Externo (Zona 2 ou 21 e 22)

LED Luminaire for Explosive Atmospheres with External Housing (Zone 2 or 21 and 22) / Luminária LED para Atmosferas Explosivas com Carcasa Externa (Zona 2 o 21 y 22)

Linha Maranduba · CLY(F)

Maranduba Line / Línea Maranduba

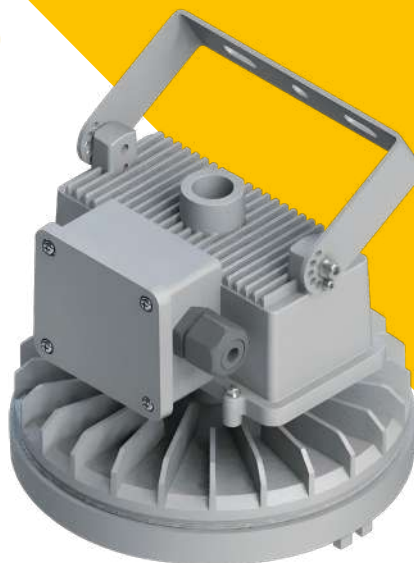

20W

30W

45W

60W

80W

90W

A Nova linha CLY(F) possui sistema de ligação de cabos mais eficiente e seguro. Corpo de alta resistência e dissipação térmica excepcional. Versátil, com diversas aplicações e suportes.

The new CLY(F) line features a more efficient and secure cable connection system. High-strength body and exceptional heat dissipation. Versatile, with various applications and supports.

La nueva línea CLY(F) cuenta con un sistema de conexión de cables más eficiente y seguro. Cuerpo de alta resistencia y disipación térmica excepcional. Versátil, con diversas aplicaciones y soportes.



Grau de proteção IP66 (a pedido IP66W**)

Degree of protection IP66 (on request IP66W**) / Grado de protección IP66 (bajo pedido IP66W**)



Sistema de Dissipação Eficiente

Efficient Dissipation System / Sistema De Disipación Eficiente



Diversas Opções de Instalação e Aplicação

Multiple Installation and Application Options / Diversas Opciones de Instalación y Aplicación

Aplicações Highlights / Destacar



Plataformas
Platforms / Plataformas



Hidrelétricas
Hydroelectric Plants / Plantas Hidroeléctricas



Refinarias
Refineries / Refinerías

Indústrias
Industries / Industrias

Usinas
Mills / Molinos

Ambientes Internos e Externos

Indoor and Outdoor Environments / Ambientes interiores y exteriores

Áreas Agressivas

Aggressive Areas / Zonas Agresivas

Áreas Classificadas

Classified Areas / Areas Clasificadas

Zonas 2, 21 ou 22

Zones 2, 21 or 22 / Zonas 2, 21 o 22

Grupos IIA, IIB, IIC ou IIIA, IIIB, IIIC

Groups / Grupos IIA, IIB or IIIA, IIIB, IIIC

Ex ec nC IIC T* Gc

Ex tb op is IIIC T***C Db

Classe de Temperatura

Temperature Class / Clase de temperatura

-20°C a +40°C

2F/ 3F/ 5F (*T4 / **T94°C)

7F/ 9F/ 11F (*T5 / **T92°C)

Classe de Temperatura

Temperature Class / Clase de temperatura

-20°C a +50°C

2F/ 3F/ 5F (*T4 / **T104°C)

7F/ 9F/ 11F (*T5 / **T102°C)

*Dependendo da aplicação e área de utilização. Depending on application and area of use. / Dependiendo de la aplicación y el área de uso

**W: adequado para ambiente salino com uso de parafusos externos em aço inox 316 (a pedido). W: suitable for saline environments with the use of external 316 stainless steel screws (on request). / W: apto para ambientes salinos con el uso de tornillos externos de acero inoxidable 316 (bajo pedido).



Sistema de fixação independente, sem passagem para o interior da luminária

Independent fixing system, without passage into the luminaire / Sistema de fijación independiente, sin paso al interior de la luminaria

Conector para cabos até 4mm²

Connector for cables up to 4mm² / Conector para cables de hasta 4mm²

Parafusos Imperdíveis

Captive Screws / Tornillos Cautivos

Alimentação por prensa cabo independente do tipo de fixação

Feeding via cable gland regardless of the type of fixing / Alimentación mediante prensaestopas independientemente del tipo de fijación

Borracha de vedação em silicone IP66

IP66 silicone sealing rubber / Goma de sellado de silicona IP66

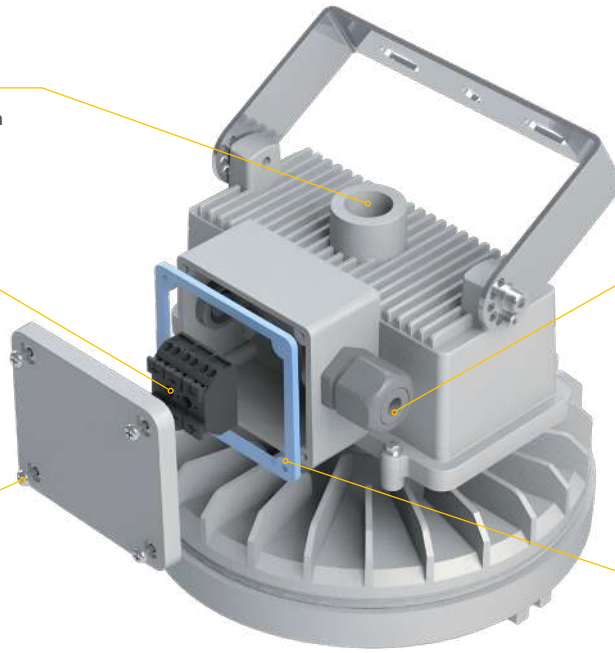

Normas Standards / Normas

NBR IEC - 60598-1 / NBR IEC - 62031 / IES LM 80-08 / IES TM 21 / ABNT NBR IEC 60079-0, 60079-7, 60079-15, 60079-28, 60079-31, 60529



Corpo 1

Body 1 / Cuerpo 1
2F (20W) / 3F (30W)
/ 5F (45W)



Corpo 2

Body 2 / Cuerpo 2
7F (60W) / 9F (80W)
/ 11F (90W)



Arandela 30°

Wall light 30° / Aplique de pared 30°



Arandela 90°

Wall light 90° / Aplique de pared 90°



Pendente

Pendant / Pendiente



Plafonier

Ceiling light / Lámpara de techo



Suporte para poste 30°

Support for post 30° / Soporte para poste 30°



Suporte para poste 90°

Support for post 90° / Soporte para poste 90°



Alça de fixação

Fixing strap / Correa de fijación

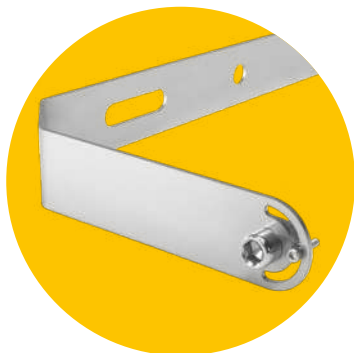

Alça e Parafusos em Inox 304 fornecidos como padrão

304 Stainless Steel Handle and Screws supplied as standard / Manija y Tornillos de Acero Inoxidable 304 suministrados como estándar

Curvas Fotométricas Photometric Curves / *Curvas Fotométricas*

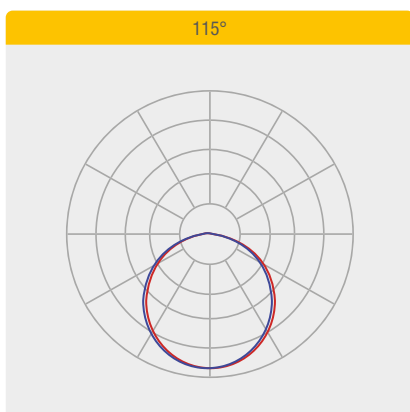

CLY-PDT

Padrão: Entrada pendente 3/4" NPT / 1 Prensa cabo M20 (6-12mm²) e 1 Bujão M20
 Standard: 3/4" NPT pendant entry / 1 M20 cable gland (6-12mm²) and 1 M20 plug / Estándar: entrada colgante de 3/4" NPT / 1 prensaestopas M20 (6-12 mm²) y 1 enchufe M20

Corpo 1
Body 1 / Cuerpo 1

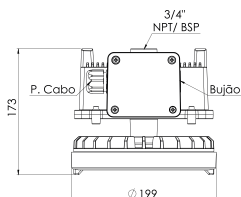

Corpo 2
Body 2 / Cuerpo 2

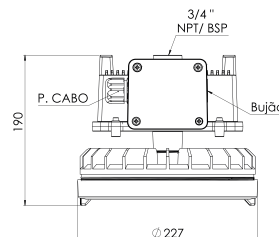



CLY-A30

Padrão: 4 Entradas 3/4" NPT com Bujão / 1 Prensa cabo M20 (6-12mm²) e 1 bujão M20
 Standard: 4 3/4" NPT Inlets with Plug / 1 M20 cable gland (6-12mm²) and 1 M20 plug / Estándar: 4 entradas NPT de 3/4" con enchufe / 1 prensaestopas M20 (6-12 mm²) y 1 enchufe M20

Corpo 1
Body 1 / Cuerpo 1

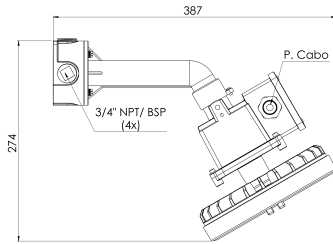

Corpo 2
Body 2 / Cuerpo 2

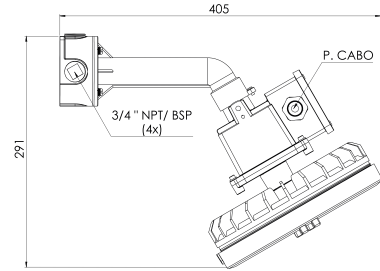

CLY-A90

Padrão: 4 Entradas 3/4" NPT com Bujão / 1 Prensa cabo M20 (6-12mm²) e 1 bujão M20
 Standard: 4 3/4" NPT Inlets with Plug / 1 M20 cable gland (6-12mm²) and 1 M20 plug / Estándar: 4 entradas NPT de 3/4" con enchufe / 1 prensaestopas M20 (6-12 mm²) y 1 enchufe M20

Corpo 1
Body 1 / Cuerpo 1

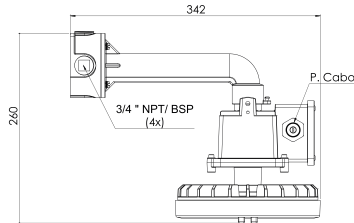

Corpo 2
Body 2 / Cuerpo 2

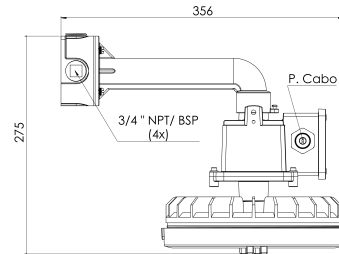

CLY-PLF

Padrão: 1 Prensa cabo M20 (6-12mm²) e 1 bujão M20
 Standard: 1 M20 cable gland (6-12mm²) and 1 M20 plug / Estándar: 1 prensaestopas M20 (6-12 mm²) y 1 conector M20

Corpo 1
Body 1 / Cuerpo 1

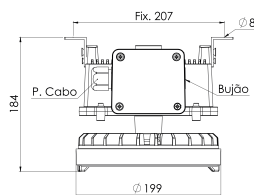

Corpo 2
Body 2 / Cuerpo 2

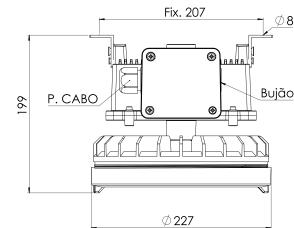

CLY-SP3

Padrão: Entrada para poste 1.1/2" BSP / 2 Prensa cabos M20 (6-12mm²) e 1 Bujão M20
 Standard: Entry for 1.1/2" BSP post / 2 M20 cable glands (6-12mm²) and 1 M20 plug / Estándar: Entrada para poste BSP de 1.1/2" / 2 prensaestopas M20 (6-12mm²) y 1 tapón M20

Corpo 1
Body 1 / Cuerpo 1

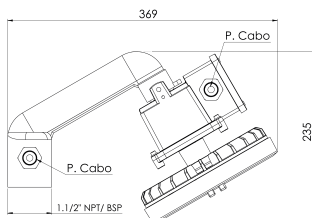

Corpo 2
Body 2 / Cuerpo 2

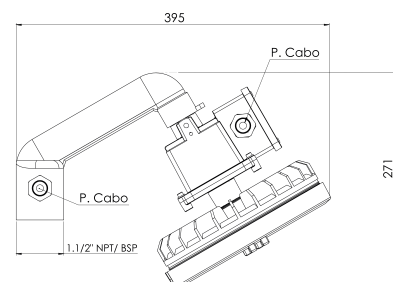



CLY-SP9

Padrão: Entrada para poste 1.1/2" BSP / 2 Prensa cabos M20 (6-12mm²) e 1 Bujão M20
Standard: Entry for 1.1/2" BSP pole / 2 M20 cable glands (6-12mm²) and 1 M20 plug / Estándar: Entrada para poste BSP de 1,1/2" / 2 prensaestopas M20 (6-12 mm²) y 1 enchufe M20

Corpo 1
Body 1 / Cuerpo 1

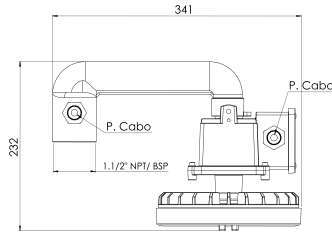

Corpo 2
Body 2 / Cuerpo 2

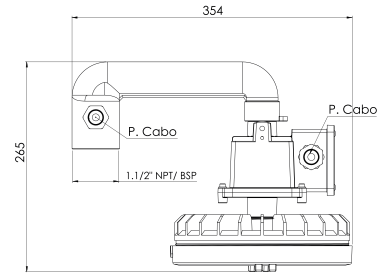

CLY-ALC

Padrão: Entrada pendente 3/4" NPT / 1 Prensa cabo M20 (6-12mm²) e 1 bujão M20
Standard: 3/4" NPT pendant entry / 1 M20 cable gland (6-12mm²) and 1 M20 plug / Estándar: entrada colgante NPT de 3/4" / 1 prensaestopas M20 (6-12 mm²) y 1 enchufe M20

Corpo 1
Body 1 / Cuerpo 1

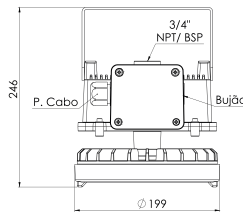

Corpo 2
Body 2 / Cuerpo 2

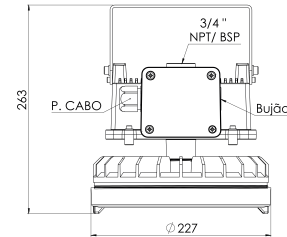

Informações Técnicas *Technical Information / Informaciones Técnicas*

Características Gerais <i>General Features / Características Generales</i>	CLY-PDT / CLY-A30 / CLY-A90 / CLY-PLF / CLY-SP3 / CLY-SP9 / CLY-ALC					
	2F	3F	5F	7F	9F	11F
Consumo do Sistema <i>System Consumption / Consumo del Sistema</i>	20W (±10%)	30W (±10%)	45W (±10%)	60W (±10%)	80W (±10%)	90W (±10%)
Tensão de trabalho padrão <i>Standard working voltage / Voltaje de trabajo estándar</i>	220-240 VAC / 90-305 VAC / 100-280 VCC					
Frequência de operação <i>Operation Frequency / Frecuencia de Operación</i>	50/60Hz					
Fator de Potência (à plena carga) <i>Power Factor (at full load) / Factor de Potencia (a plena carga)</i>	>0.98 @ 115VAC, >0.95@230VAC >0.93@277VAC					
Condição de Utilização <i>Conditions of Use / Condiciones de Uso</i>	Altitude: 1500m / Temperatura Média do ar: +40°C / Temperatura do ar ambiente: -40°C ~ +60°C / Umidade relativa do ar: até 100%					
Tipo de Proteção elétrica/eletrônica <i>Protection type electrical - electronic / Tipo de protección eléctrica - electrónica</i>	Curto-Circuito, Sobretensão, Sobrecorrente, Sobreaquecimento					
Grau de Proteção <i>Protection Grade / Grado de Protección</i>	Padrão: IP66 / Opcional: IP66W					
Grau de Impacto <i>Impact Grade / Grado de Impacto</i>	IK08					
Protetor de Surto <i>Surge Protector / Protector contra Sobretensiones</i>	DPS 10kA					



Características Fotométricas e Óticas <i>General and Photometric Features / Características Generales y Fotométricas</i>	CLY-PDT / CLY-A30 / CLY-A90 / CLY-PLF / CLY-SP3 / CLY-SP9 / CLY-ALC					
	2F	3F	5F	7F	9F	11F
Índice de Reprodução de Cores <i>Color Rendering Index / Índice de Reproducción de Color</i>	>80					
Temperatura de Cor Padrão <i>Standard Color Temperature / Temperatura de Color Estándar</i>	5 000K (±275K)					
Ângulo do fecho padrão <i>Beam Opening Angle / Ángulo de Apertura del Haz</i>	115°					
Fator de Depreciação Luminosa <i>Light Depreciation Factor / Factor de Depreciación Leve</i>	até 10% para 50 000h @ 1,0A e Tj=85°C					
Vida Útil <i>Estimated Service Life / Vida Estimada</i>	100 000h (L70 B50)					
Fluxo Luminoso da Luminária (@Tj65°C) <i>Luminous Flux of the Fixture / Corrientes de luz de la luminaria</i>	3000 (±10%)	4500 (±10%)	6750 (±10%)	8100 (±10%)	10400 (±10%)	12000 (±10%)
Eficiência da Luminária (@Tj65°C) <i>Luminaire Efficiency / Eficiencia luminaria</i>	150lm/w (±10%)	150lm/w (±10%)	150lm/w (±10%)	135lm/w (±10%)	130lm/w (±10%)	135lm/w (±10%)

Características Construtivas <i>Constructive Features / Características Constructivas</i>	CLY-PDT / CLY-A30 / CLY-A90 / CLY-PLF / CLY-SP3 / CLY-SP9 / CLY-ALC					
	2F	3F	5F	7F	9F	11F
Material do Corpo <i>Body Material / Cuerpo Material</i>	Alumínio copper free					
Material do Visor <i>Display Material / Material de Exhibición</i>	Padrão: Vidro Jateado (Antiofuscante) / Opcional: Policarbonato transparente					
Entrada Rosqueada <i>Threaded Entry / Entrada Roscada</i>	NPT / BSP / MÈTRICA					

Medidas <i>Measures / Medidas</i>	CLY-PDT	CLY-A30	CLY-A90	CLY-PLF	CLY-SP3	CLY-SP9	CLY-ALC
Tamanho Corpo 1 <i>Body Size 1 / Tamaño del Cuerpo 1</i>	199x173mm	387x274mm	342x260mm	199x184mm	369x235mm	341x232mm	199x246mm
Tamanho Corpo 2 <i>Body Size 2 / Tamaño del Cuerpo 2</i>	227x190mm	405x291mm	356x275mm	227x199mm	395x271mm	354x265mm	227x263mm
Peso Corpo 1 <i>Body Weight 1 / Peso Cuerpo 1</i>	2,8Kg	3,5Kg	3,5Kg	2,8Kg	3,8Kg	3,8Kg	3,1Kg
Peso Corpo 2 <i>Body Weight 2 / Peso Cuerpo 2</i>	4,9Kg	5,6Kg	5,6Kg	4,9Kg	5,9Kg	5,9Kg	5,2Kg
Instalação <i>Installation / Instalación</i>	Fixado Pendente <i>Fixed Pending / Pendiente Fija</i>	Arandela 30° <i>Sconce 30° / Candelabro de Pared 30°</i>	Arandela 90° <i>Sconce 90° / Candelabro de Pared 90°</i>	Plafonier <i>Ceiling Light / Lámpara de Techo</i>	Poste 30° <i>Pole 30° / Poste 30°</i>	Poste 90° <i>Pole 90° / Poste 90°</i>	Alça e Pendente <i>Strap / Bandolera</i>

Comparativo LED X Convencional <i>Comparative LEDXConventional / Comparativo LEDXConvencional</i>	CLY-PDT / CLY-A30 / CLY-A90 / CLY-PLF / CLY-SP3 / CLY-SP9 / CLY-ALC					
	2F	3F	5F	7F	9F	11F
Equivalência <i>Equivalence / Equivalencia</i>	HID 50W	HID 70W	HID 100W	HID 150W	HID 200W	HID 250W



Codificação Codification / Codificación

CLY

Linha Line / Línea
CLY

PDT

Modelo Model / Modelo	
PDT	Pendente
A30	Arandela 30°
A90	Arandela 90°
PLF	Plafonier
SP3	Suporte para poste 30°
SP9	Suporte para poste 90°
ALC	Alça e Pendente

2F

Potência Power / Potencia	
2F	20W
3F	30W
5F	45W
7F	60W
9F	80W
11F	90W

K50

Temperatura de Cor Color Temp. / Temp. del Color	
K50	5000K
K30	3000K
K57	5700K

VD12

Tensão de Trabalho Working Voltage / Tensión de Trabajo	
padrão	220/240VAC
VD12	12VCC
VD24	24VCC
VCC	90-305VAC / 100-280VCC

TA

PC12N

*3 Anos de Garantia na Condição CR

*3 Years Warranty in CR Condition / *3 Años de Garantía en Condición CR

**Para a rosca BSP, substituir a letra N por B - Exemplo:PC12B = Prensa cabo 1/2" BSP

For the BSP thread, replace the letter N with B - Example: PC12B = 1/2" BSP cable gland / Para la rosca BSP, reemplaza la letra N por B - Ejemplo: PC12B = prensaestopas 1/2" BSP

Consulte-nos: luminárias com alimentação em tensão especial (12VCC / 24VCC / 90-305VAC / 100-280VCC)

Consult us: luminaires with special voltage supply / Consúltenos: luminarias con tensión de alimentación especial

Acessórios

Accessories / Accesorios

TA	Terminal olhal de segurança para ancoragem Anchor Safety Eye Terminal / Terminal de Ojo de Seguridad de Ancla
CR	Pintura Especial Conexrevest* Special Painting Conexrevest* / Pintura Especial Conexrevest*
DP	Difusor em Policarbonato Polycarbonate Diffuser / Difusor de Policarbonato
DJ	Difusor em Vidro Jateado Sandblasted Glass Diffuser / Difusor de Vidrio Arenado
T34	Conexão T 3/4" para Instalação Pendente Connection T 3/4" for Suspended Installation / Conexión en T 3/4" para Instalación Suspendida

Prensa Cabo**

Cable Gland / Prensa de Cable

Padrão	Prensa cabo M20 (6-12mm) M20 cable gland / Prensa cables M20
PCM25	Prensa cabo M25 (12-16mm) M25 cable gland / Prensa cables M25
PC12N	Prensa cabo 1/2"NPT (6-12mm) 1/2"NPT cable gland / Prensa cables de 1/2"NPT
PC34N	Prensa cabo 3/4"NPT (12-16mm) 3/4"NPT cable gland / Prensa cables de 3/4"NPT