

Luminária LED para Atmosferas Explosivas com Módulo de Emergência (Zona 1 e 2 ou 21 e 22)

LED Luminaire for Explosive Atmospheres with Emergency Module (Zone 1 and 2 or 21 and 22) / Luminaria LED para Atmosféras Explosivas con Modulo de Emergencia (Zona 1 y 2 o 21 y 22)

Linha Sapê • CLYX-E

Sapê Line / Línea Sapê

20W	28W	43W	60W
78W	92W	119W	135W



Versátil, com diversas aplicações e suportes. Funcionamento com alimentação convencional e em modo de emergência com utilização de baterias.

Versatile, with different applications and supports. Operation with conventional power supply and in emergency mode using batteries.

Versátil, con diferentes aplicaciones y soportes. Funcionamiento con alimentación convencional y en modo de emergencia mediante baterías.



Sistema de Dissipação Eficiente

Efficient Dissipation System / Sistema De Disipación Eficiente



Design Compacto e Funcional

Compact and Functional Design / Diseño Compacto Y Funcional



Autonomia de 120 Minutos

120-Minute Battery Life / Duración de la Batería de 120 Minutos

Aplicações Highlights / Destacar



Plataformas
Platforms / Plataformas



Hidrelétricas
Hydroelectric Plants /
Plantas Hidroeléctricas



Refinarias
Refinerías / Refinerías



Indústrias
Industries / Industrias



Usinas
Mills / Molinos

Ambientes Internos e Externos
Indoor and Outdoor Environments / Ambientes interiores y exteriores

Áreas Agressivas
Aggressive Areas / Zonas Agresivas

Áreas Classificadas
Classified Areas / Areas Clasificadas

Áreas Classificadas:

Classified Areas / Areas Clasificadas

Zonas 1 ou 2, 21 ou 22

Zones 1 or 2, 21 or 22 / Zonas 1 o 2, 21 o 22

Grupos IIA, IIB, IIC ou IIIA, IIIB, IIIC

Groups / Grupos IIA, IIB or IIIA, IIIB, IIIC

Ex eb mb op is IIC T* Gb - Gases e Vapores

Ex tb op is IIIC TC Db - Poeiras Combustíveis**

Classe de Temperatura:

Temperature Class: / Clase de temperatura:

20°C a +40°C

2D/ 3D/ 5D (T4 / **T94°C)

7D/ 9D/ 11D (T5 / **T92°C)

12D/ 15D (T4 / **T102°C)

Classe de Temperatura:

Temperature Class: / Clase de temperatura:

-20°C a +50°C

2D/ 3D/ 5D (T4 / **T104°C)

7D/ 9D/ 11D (T5 / **T102°C)

12D/ 15D (T3 / **T112°C)

* Bateria - garantia de 12 meses. Battery - 12 month warranty. / Batería - Garantía de 12 meses.



Corpo 1 Médio

Body 2 Medium / Cuerpo 2 Medio

2D(23W) / 3D(32W) / 5D(43W) / 7D(60W) 9D(78W) / 11D(92W)

10W Modo de Emergência
Emergency Mode / Modo de Emergencia

Corpo 2 Grande

Body 3 Large / Cuerpo 3 Grande

12D(119W) / 15D(135W)

10W Modo de Emergência
Emergency Mode / Modo de Emergencia

Normas Standards / Normas

NBR IEC - 60598-1 / NBR IEC - 62031 / IES LM 80-08 / IES TM 21 / ABNT NBR IEC 60079-0, 60079-7, 60079-18, 60079-28, 60079-31, 60529 / IES 10898



Arandela 30°

Wall light 30° / Aplique de pared 30°



Arandela 90°

Wall light 90° / Aplique de pared 90°



Pendente

Pendant / Pendiente



Plafonier

Ceiling light / Lámpara de techo



Suporte para poste 30°

Support for post 30° / Soporte para poste 30°



Suporte para poste 90°

Support for post 90° / Soporte para poste 90°



Alça de fixação

Fixing strap / Correa de fijación

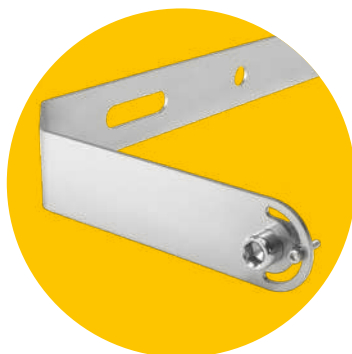

Alça e Parafusos em Inox 304 fornecidos como padrão

304 Stainless Steel Handle and Screws supplied as standard / Manija y Tornillos de Acero Inoxidable 304 suministrados como estándar



CLYX-EPDT

Fornecimento padrão com 1 entrada 3/4 NPT

Standard supply with 1 port 3/4 NPT / Suministro estándar con 1 puerto 3/4 NPT

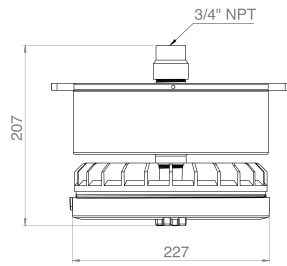

Corpo 1
Body 1 / Cuerpo 1

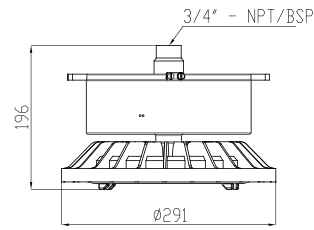

Corpo 2
Body 2 / Cuerpo 2

CLYX-EPLF

Fornecimento padrão com 4 entradas 3/4" NPT - 3 com bujão e 1 entrada aberta

Standard delivery with 4 3/4" NPT ports - 3 with plug and 1 open port / Entrega estándar con 4 puertos NPT de 3/4" - 3 con tapón y 1 puerto abierto

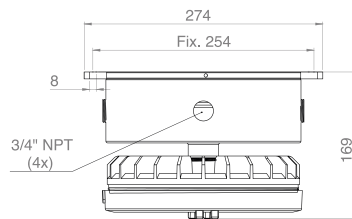

Corpo 1
Body 1 / Cuerpo 1

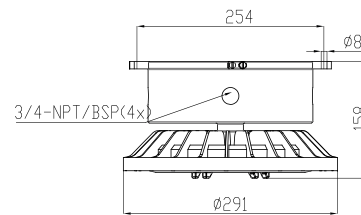

Corpo 2
Body 2 / Cuerpo 2

CLYX-EA30

Fornecimento padrão com 4 entradas 3/4" NPT - 3 com bujão e 1 entrada aberta

Standard delivery with 4 3/4" NPT ports - 3 with plug and 1 open port / Entrega estándar con 4 puertos NPT de 3/4" - 3 con tapón y 1 puerto abierto

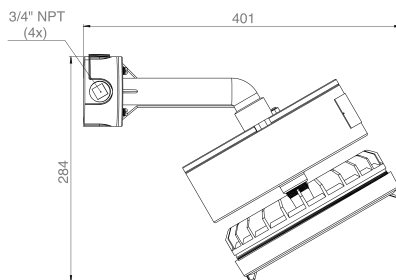

Corpo 1
Body 1 / Cuerpo 1

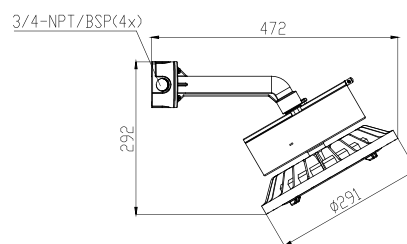

Corpo 2
Body 2 / Cuerpo 2



CLYX-EA90

Fornecimento padrão com 4 entradas 3/4" NPT - 3 com bujão e 1 entrada aberta

Standard delivery with 4 3/4" NPT ports - 3 with plug and 1 open port / Entrega estándar con 4 puertos NPT de 3/4" - 3 con tapón y 1 puerto abierto

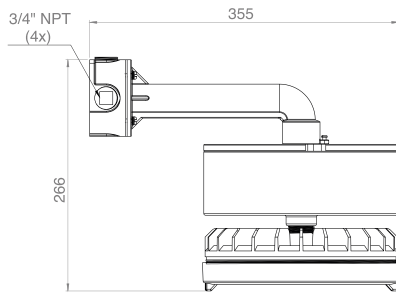

Corpo 1
Body 1 / Cuerpo 1

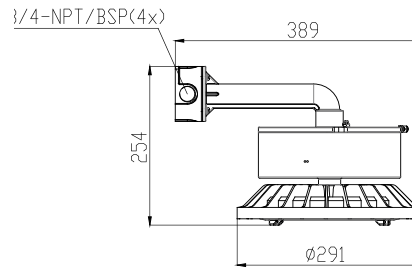

Corpo 2
Body 2 / Cuerpo 2

CLYX-ESP3

Fornecimento padrão com entrada 1.1/2" BSP

Standard delivery with 1.1/2" BSP port / Entrega estándar con puerto BSP de 1,1/2"

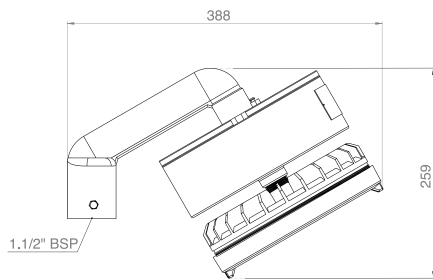

Corpo 1
Body 1 / Cuerpo 1

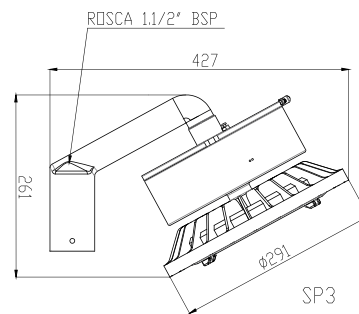

Corpo 2
Body 2 / Cuerpo 2

CLYX-ESP9

Fornecimento padrão com entrada 1.1/2" BSP

Standard delivery with 1.1/2" BSP port / Entrega estándar con puerto BSP de 1,1/2"

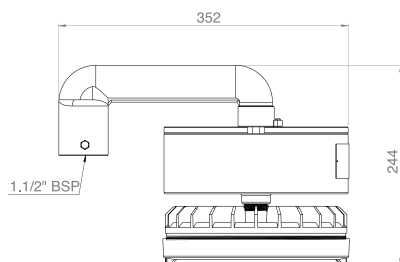

Corpo 1
Body 1 / Cuerpo 1

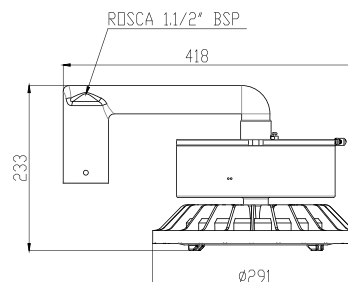

Corpo 2
Body 2 / Cuerpo 2



CLYX-EALC

Fornecimento padrão com 4 entradas 3/4" NPT - 3 com bujão e 1 entrada aberta

Standard delivery with 4 3/4" NPT ports - 3 with plug and 1 open port / Entrega estándar con 4 puertos NPT de 3/4" - 3 con tapón y 1 puerto abierto

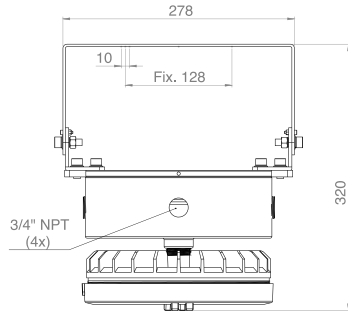

Corpo 1
Body 1 / Cuerpo 1

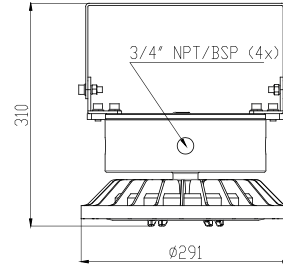

Corpo 2
Body 2 / Cuerpo 2

Curvas Fotométricas* Photometric Curves* / Curvas Fotométricas*

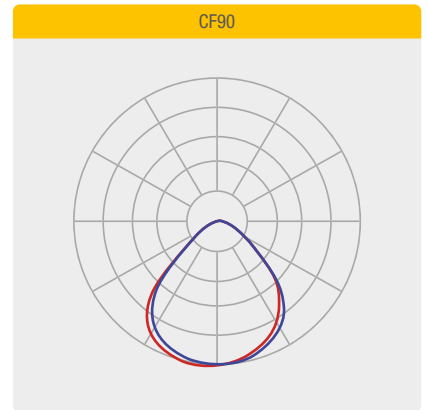
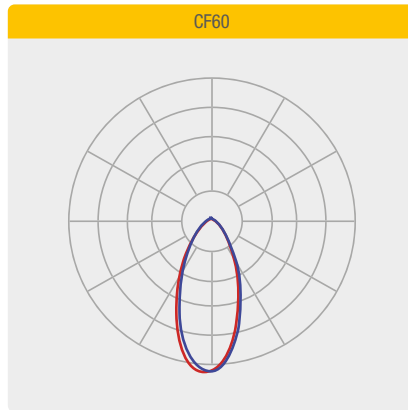
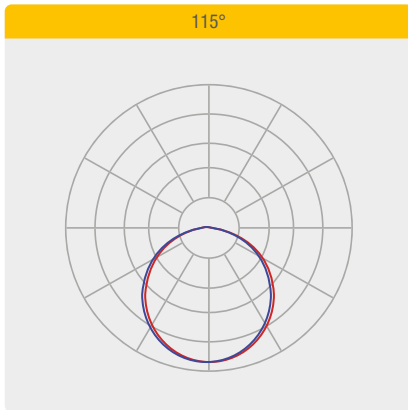

*Candelas para 1000 lumens

**Candelas for 1000 lumens / *Candelas para 1000 lúmenes*



Informações Técnicas *Technical Information / Informaciones Técnicas*

Características Gerais <i>General Features / Características Generales</i>	CLYX-EPDT / CLYX-EA30 / CLYX-EA90 / CLYX-EPLF / CLYX-ESP3 / CLYX-ESP9 / CLYX-EALC							
	2D	3D	5D	7D	9D	11D	12D	15D
Consumo do Sistema <i>System Consumption / Consumo del Sistema</i>	23W (±10%)	32W (±10%)	43W (±10%)	60W (±10%)	78W (±10%)	92W (±10%)	119W (±10%)	135W (±10%)
Consumo modo de Emergência <i>Emergency Mode Consumption / Consumo en Modo Emergencia</i>	10W							
Tensão de trabalho padrão <i>Standard working voltage / Voltaje de trabajo estándar</i>	220-240 VAC / 100-277 VAC							
Frequência de operação <i>Operation Frequency / Frecuencia de Operación</i>	50/60Hz							
Fator de Potência (à plena carga) <i>Power Factor (at full load) / Factor de Potencia (a plena carga)</i>	>0.98 @ 115VAC, >0.95@230VAC >0.93@277VAC							
Condição de Utilização <i>Conditions of Use / Condiciones de Uso</i>	Altitude: 1500m / Temperatura Média do ar: +35°C / Temperatura do ar ambiente: -20°C ~ +50°C / Umidade relativa do ar: até 100%							
Tipo de Proteção elétrica/eletrônica <i>Protection type electrical - electronic / Tipo de protección eléctrica - electrónica</i>	Curto-Circuito, Sobretensão, Sobrecorrente, Sobreaquecimento							
Grau de Proteção <i>Protection Grade / Grado de Protección</i>	IP66							
Grau de Impacto <i>Impact Grade / Grado de Impacto</i>	IK08							
Protetor de Surto <i>Surge Protector / Protector contra Sobretensiones</i>	10kA							
Bateria <i>Battery / Batería</i>	NI-CD 12V x 2,5Ah - Tempo de recarga total 24 horas - Autonomia de 120 minutos							

Características Fotométricas e Óticas <i>General and Photometric Features / Características Generales y Fotométricas</i>	CLYX-EPDT / CLYX-EA30 / CLYX-EA90 / CLYX-EPLF / CLYX-ESP3 / CLYX-ESP9 / CLYX-EALC							
	2D	3D	5D	7D	9D	11D	12D	15D
Índice de Reprodução de Cores <i>Color Rendering Index / Índice de Reproducción de Color</i>	>80							
Temperatura de Cor Padrão <i>Standard Color Temperature / Temperatura de Color Estándar</i>	5 000K (±275K)							
Ângulo do fecho padrão <i>Beam Opening Angle / Ángulo de Apertura del Haz</i>	115°							
Fator de Depreciação Luminosa <i>Light Depreciation Factor / Factor de Depreciación Leve</i>	até 10% para 50 000h @ 1,0A e Tj=85°C							
Vida Útil <i>Estimated Service Life / Vida Estimada</i>	50 000h (L70 B50)							
Fluxo Luminoso da Luminária (@Tj65°C) <i>Luminous Flux of the Fixture / Corrientes de luz de la luminaria</i>	3 220 (±10%)	4 150lm (±10%)	6 122lm (±10%)	8 100lm (±10%)	9 940lm (±10%)	11 350lm (±10%)	14 280lm (±10%)	16 158lm (±10%)
Eficiência da Luminária (@Tj65°C) <i>Luminaire Efficiency / Eficiencia luminaria</i>	139lm/w (±10%)	131lm/w (±10%)	143lm/w (±10%)	135lm/w (±10%)	127lm/w (±10%)	123lm/w (±10%)	120lm/w (±10%)	120lm/w (±10%)
Fluxo Luminoso (Modo de Emergência) <i>Luminous Flux (Emergency Mode) / Flujo Luminoso(Modo de Emergencia)</i>	1 200lm (±10%)							

Características Construtivas <i>Constructive Features / Características Constructivas</i>	CLYX-EPDT / CLYX-EA30 / CLYX-EA90 / CLYX-EPLF / CLYX-ESP3 / CLYX-ESP9 / CLYX-EALC							
	2D	3D	5D	7D	9D	11D	12D	15D
Material do Corpo <i>Body Material / Cuerpo Material</i>	Alumínio Fundido							
Material do Visor <i>Display Material / Material de Exhibición</i>	Vidro temperado de 4mm / policarbonato 4mm (antifuscente) jateado ou transparente							
Entrada Rosqueada <i>Threaded Entry / Entrada Roscada</i>	Padrão 3/4" NPT - Opcioal: 3/4" BSP ou M25 - Modelos para poste com entrada padrão: 1.1/2" BSP, opcional: 1.1/2" NPT							



Medidas <i>Measures / Medidas</i>	CLYX-EPDT	CLYX-EA30	CLYX-EA90	CLYX-EPLF	CLYX-ESP3	CLYX-ESP9	CLYX-EALC
Tamanho Corpo 1 <i>Body Size 1 / Tamaño del Cuerpo 1</i>	227x207mm	401x284mm	355x266mm	274x169mm	388x259mm	352x243mm	320x278mm
Tamanho Corpo 2 <i>Body Size 2 / Tamaño del Cuerpo 2</i>	291x196mm	292x472mm	254x389mm	254x158mm	427x261mm	418x233mm	291x310mm
Peso Corpo 1 <i>Body Weight 1 / Peso Cuerpo 1</i>	4,9Kg	5,6Kg	5,6Kg	4,9Kg	5,9Kg	5,9Kg	5,2Kg
Peso Corpo 2 <i>Body Weight 2 / Peso Cuerpo 2</i>	5,4Kg	6,1Kg	6,1Kg	5,4Kg	6,4Kg	6,4Kg	5,7Kg
Instalação <i>Installation / Instalación</i>	Fixado Pendente <i>Fixed Pending / Pendiente Fija</i>	Arandela 30° <i>Sconce 30° / Candelabro de Pared 30°</i>	Arandela 90° <i>Sconce 90° / Candelabro de Pared 90°</i>	Plafonier <i>Ceiling Light / Lámpara de Techo</i>	Poste 30° <i>Pole 30° / Poste 30°</i>	Poste 90° <i>Pole 90° / Poste 90°</i>	Alça <i>Strap / Bandolera</i>

Codificação Codification / Codificación

CLYX-E

Linha <i>Line / Línea</i>
CLYX-E

PDT

Modelo <i>Model / Modelo</i>	
PDT	Pendente
A30	Arandela 30°
A90	Arandela 90°
PLF	Plafonier
SP3	Suporte para poste 30°
SP9	Suporte para poste 90°
ALC	Alça

3D

Potência <i>Power / Potencia</i>	
2D	23W
3D	32W
5D	43W
7D	60W
9D	78W
11D	92W
12D	119W
15D	135W

K50

Temp. de Cor <i>Color Temp. / Temp. del Color</i>	
K50	5000K

CF90

Tipo de Lente <i>Lens Type / Tipo de Lente</i>	
padrão	115°
CF60	60°
CF90	90°

TA

Acessórios sob Encomenda <i>Custom Accessories / Accesorios Personalizados</i>	
TA	Terminal olhal de segurança para ancoragem <i>Anchor Safety Eye Terminal / Terminal de Ojo de Seguridad de Ancla</i>
CR	Pintura Especial Conexrevest* <i>Special Painting Conexrevest* / Pintura Especial Conexrevest*</i>
DP	Difusor em Policarbonato <i>Polycarbonate Diffuser / Difusor de Policarbonato</i>

*Para utilização em ambientes altamente corrosivos:
Garantia de 3 Anos.

*For use in highly corrosive environments: 3-Year Warranty / *Para uso en ambientes altamente corrosivos: Garantía de 3 años.

Prensa Cabo Alumínio Ex**

*Ex Aluminum Cable Gland** / Prensa de Cable de Aluminio Ex***

PC12	Prensa cabo 1/2" <i>1/2" cable gland / Prensacables de 1/2"</i>
PC34	Prensa cabo 3/4" <i>3/4" cable gland / Prensacables de 3/4"</i>
PC25	Prensa cabo M25 <i>M25 cable gland / Prensacables de M25</i>

**Prensa cabos disponíveis sob encomenda

**Cable glands available on request / **Prensaestopas disponibles bajo pedido

Tensão de Trabalho

Working Voltage / Tensión de Trabajo

padrão	220/240VAC
BV	100-277VAC