

Luminária LED para Atmosferas Explosivas (Zona 1 e 2 ou 21 e 22)

LED Luminaire for Explosive Atmospheres (Zone 1 and 2 or 21 and 22) / Luminária LED para Atmosferas Explosivas (Zona 1 y 2 o 21 y 22)

Linha Sapê • CLYX(D)

Sapê Line / Línea Sapê



- 20W
- 30W
- 45W
- 60W
- 80W
- 90W

Alta resistência mecânica e à corrosão, possui projeto de dissipação térmica excepcional. Versátil, com diversas aplicações e suportes.

High mechanical and corrosion resistance, has an exceptional thermal dissipation design. Versatile, with different applications and supports.

Alta resistencia mecánica y a la corrosión, tiene un diseño de dissipación térmica excepcional. Versátil, con diferentes aplicaciones y soportes.



Sistema de Dissipação Eficiente

Efficient Dissipation System / Sistema De Disipación Eficiente



Design Compacto e Funcional

Compact and Functional Design / Diseño Compacto Y Funcional



Difusor Antiofuscamento (Jateado)

Anti-glare Diffuser (blasted) / Difusor Antideslumbrante (chorreado)

Aplicações Highlights / Destacar



Plataformas
Platforms / Plataformas



Hidrelétricas
Hydroelectric Plants /
Plantas Hidroeléctricas



Refinarias
Refineries / Refinerías



Indústrias
Industries / Industrias



Usinas
Mills / Molinos

Ambientes Internos e Externos

Indoor and Outdoor Environments / Ambientes interiores y exteriores

Áreas Agressivas

Aggressive Areas / Zonas Agresivas

Áreas Classificadas

Classified Areas / Areas Clasificadas

Zonas 1 ou 2, 21 ou 22

Zones 1 or 2, 21 or 22 / Zonas 1 o 2, 21 o 22

Grupos IIA, IIB, IIC ou IIIA, IIIB, IIIC

Groups / Grupos IIA, IIB or IIIA, IIIB, IIIC

Ex eb mb op is IIC T* Gb

Ex tb op is IIIC T**°C Db

Classe de Temperatura

Temperature Class / Clase de temperatura

-20°C a +40°C

2D/ 3D/ 5D (*T4 / **T94°C)

7D/ 9D/ 11D (*T5 / **T92°C)

Classe de Temperatura

Temperature Class / Clase de temperatura

-20°C a +50°C

2D/ 3D/ 5D (*T4 / **T104°C)

7D/ 9D/ 11D (*T5 / **T102°C)

*Dependendo da aplicação e área de utilização. Depending on application and area of use. / Dependiendo de la aplicación y el área de uso



Corpo 1 Pequeno

Body 1 Small / Cuerpo 1 Pequeño
2D(20W) / 3D(30W) / 5D(45W)



Corpo 2 Médio

Body 2 Medium / Cuerpo 2 Medio
7D(60W) / 9D(80W) / 11D(90W)

Normas Standards / Normas

NBR IEC - 60598-1 / NBR IEC - 62031 / IES LM 80-08 / IES TM 21 / ABNT NBR IEC 60079-0, 60079-7, 60079-15, 60079-28, 60079-31, 60529



Arandela 30°

Wall light 30° / Aplique de pared 30°



Arandela 90°

Wall light 90° / Aplique de pared 90°



Pendente

Pendant / Pendiente



Plafonier

Ceiling light / Lámpara de techo



Suporte para poste 30°

Support for post 30° / Soporte para poste 30°



Suporte para poste 90°

Support for post 90° / Soporte para poste 90°



Alça de fixação

Fixing strap / Correa de fijación

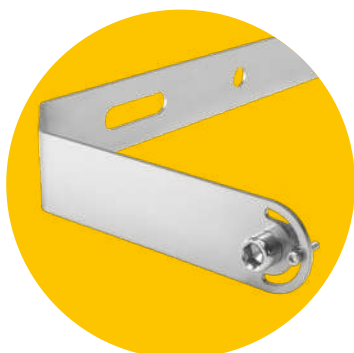

Alça e Parafusos em Inox 304 fornecidos como padrão

304 Stainless Steel Handle and Screws supplied as standard / Manija y Tornillos de Acero Inoxidable 304 suministrados como estándar



CLYX-PDT

Fornecimento padrão com 1 entrada 3/4 NPT

Standard supply with 1 port 3/4 NPT / Suministro estándar con 1 puerto 3/4 NPT

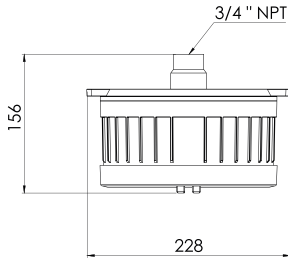

Corpo 1
Body 1 / Cuerpo 1

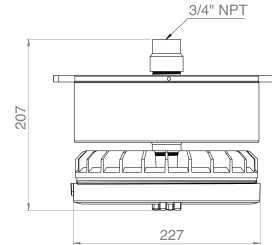

Corpo 2
Body 2 / Cuerpo 2

CLYX-PLF

Fornecimento padrão com 4 entradas 3/4" NPT - 3 com bujão e 1 entrada aberta

Standard delivery with 4 3/4" NPT ports - 3 with plug and 1 open port / Entrega estándar con 4 puertos NPT de 3/4" - 3 con tapón y 1 puerto abierto

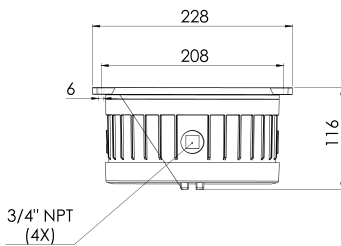

Corpo 1
Body 1 / Cuerpo 1

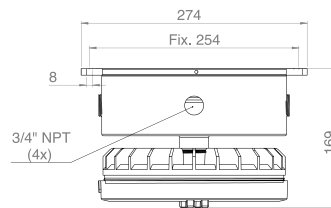

Corpo 2
Body 2 / Cuerpo 2

CLYX-A30

Fornecimento padrão com 4 entradas 3/4" NPT - 3 com bujão e 1 entrada aberta

Standard delivery with 4 3/4" NPT ports - 3 with plug and 1 open port / Entrega estándar con 4 puertos NPT de 3/4" - 3 con tapón y 1 puerto abierto

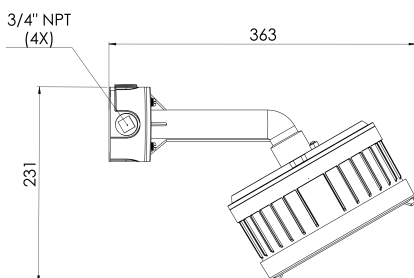

Corpo 1
Body 1 / Cuerpo 1

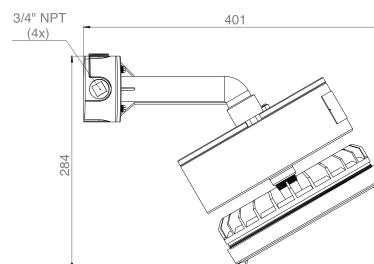

Corpo 2
Body 2 / Cuerpo 2



CLYX-A90

Fornecimento padrão com 4 entradas 3/4" NPT - 3 com bujão e 1 entrada aberta

Standard delivery with 4 3/4" NPT ports - 3 with plug and 1 open port / Entrega estándar con 4 puertos NPT de 3/4" - 3 con tapón y 1 puerto abierto

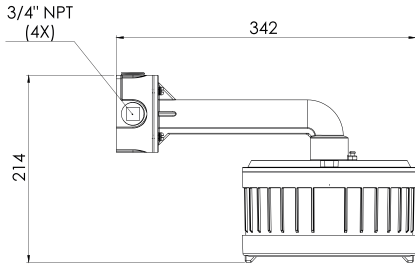

Corpo 1
Body 1 / Cuerpo 1

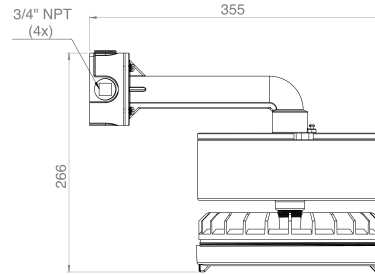

Corpo 2
Body 2 / Cuerpo 2

CLYX-SP3

Fornecimento padrão com entrada 1.1/2" BSP

Standard delivery with 1.1/2" BSP port / Entrega estándar con puerto BSP de 1,1/2"

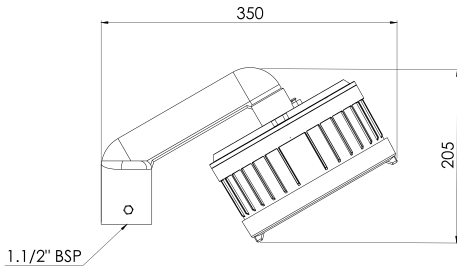

Corpo 1
Body 1 / Cuerpo 1

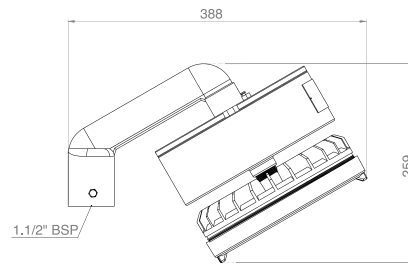

Corpo 2
Body 2 / Cuerpo 2

CLYX-SP9

Fornecimento padrão com entrada 1.1/2" BSP

Standard delivery with 1.1/2" BSP port / Entrega estándar con puerto BSP de 1,1/2"

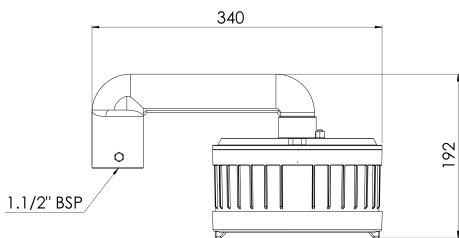

Corpo 1
Body 1 / Cuerpo 1

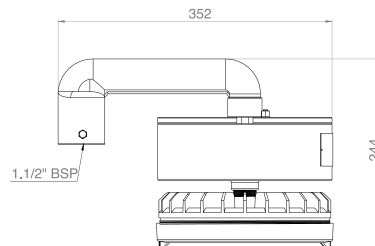

Corpo 2
Body 2 / Cuerpo 2



CLYX-ALC

Fornecimento padrão com 4 entradas 3/4" NPT - 3 com bujão e 1 entrada aberta

Standard delivery with 4 3/4" NPT ports - 3 with plug and 1 open port / Entrega estándar con 4 puertos NPT de 3/4" - 3 con tapón y 1 puerto abierto

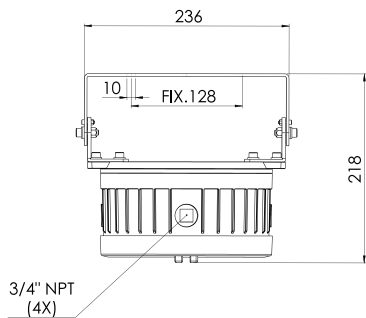

Corpo 1
Body 1 / Cuerpo 1

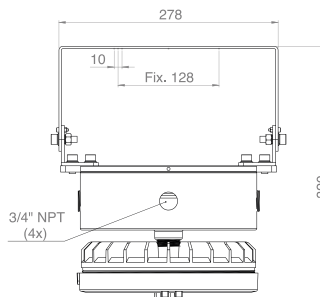

Corpo 2
Body 2 / Cuerpo 2

Curvas Fotométricas Photometric Curves / *Curvas Fotométricas*

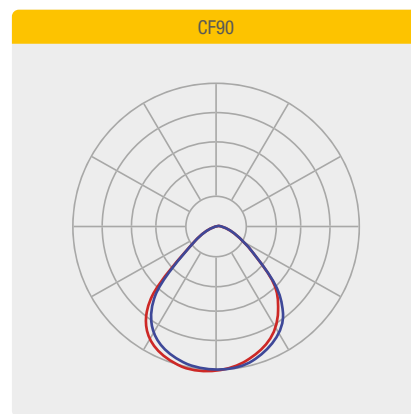
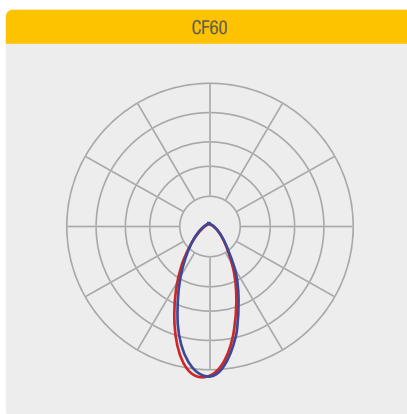
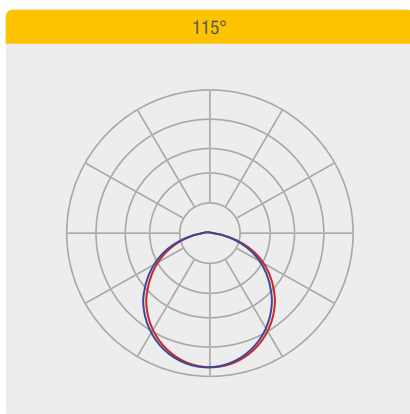

Candelas para 1000 lumens

Candelas for 1000 lumens / Candelas para 1000 lúmenes



Informações Técnicas *Technical Information / Informaciones Técnicas*

Características Gerais <i>General Features / Características Generales</i>	CLYX-PDT / CLYX-A30 / CLYX-A90 / CLYX-PLF / CLYX-SP3 / CLYX-SP9 / CLYX-ALC					
	2D	3D	5D	7D	9D	11D
Consumo do Sistema <i>System Consumption / Consumo del Sistema</i>	20W (±10%)	30W (±10%)	45W (±10%)	60W (±10%)	80W (±10%)	90W (±10%)
Tensão de Trabalho <i>Working Voltage / Voltaje de Trabajo</i>	220-240 VAC / 90-305 VAC / 100-280 VCC					
Frequência de Operação <i>Operation Frequency / Frecuencia de Operación</i>	50/60Hz					
Fator de Potência (à plena carga) <i>Power Factor (at full load) / Factor de Potencia (a plena carga)</i>	>0.98 @ 115VAC, >0.95@230VAC >0.93@277VAC					
Condição de Utilização <i>Conditions of Use / Condiciones de Uso</i>	Altitude: 1500m / Temperatura Média do ar: +35°C / Temperatura do ar ambiente: -20°C ~ +50°C / Umidade relativa do ar: até 100%					
Tipo de Proteção elétrica/eletrônica <i>Protection type electrical - electronic / Tipo de protección eléctrica - electrónica</i>	Curto-Circuito, Sobretensão, Sobrecorrente, Sobreaquecimento					
Grau de Proteção <i>Protection Grade / Grado de Protección</i>	IP66					
Grau de Impacto <i>Impact Grade / Grado de Impacto</i>	IK08					

Características Fotométricas e Óticas <i>General and Photometric Features / Características Generales y Fotométricas</i>	CLYX-PDT / CLYX-A30 / CLYX-A90 / CLYX-PLF / CLYX-SP3 / CLYX-SP9 / CLYX-ALC					
	2D	3D	5D	7D	9D	11D
Índice de Reprodução de Cores <i>Color Rendering Index / Índice de Reproducción de Color</i>	>70					
Temperatura de Cor Padrão <i>Standard Color Temperature / Temperatura de Color Estándar</i>	5 000K (±275K)					
Ângulo do fecho padrão <i>Beam Opening Angle / Ángulo de Apertura del Haz</i>	115°					
Fator de Depreciação Luminosa <i>Light Depreciation Factor / Factor de Depreciación Leve</i>	até 10% para 50 000h @ 1,0A e Tj=85°C					
Vida Útil <i>Estimated Service Life / Vida Estimada</i>	100 000h (L70 B50)					
Fluxo Luminoso da Luminária (@Tj65°C) <i>Luminous Flux of the Fixture / Corrientes de luz de la luminaria</i>	2 900lm (±10%)	4 040lm (±10%)	6 122lm (±10%)	8 100lm (±10%)	9 940lm (±10%)	11 350lm (±10%)
Eficiência da Luminária (@Tj65°C) <i>Luminaire Efficiency / Eficiencia luminaria</i>	144lm/w (±10%)	145lm/w (±10%)	143lm/w (±10%)	135lm/w (±10%)	127lm/w (±10%)	123lm/w (±10%)

Características Construtivas <i>Constructive Features / Características Constructivas</i>	CLYX-PDT / CLYX-A30 / CLYX-A90 / CLYX-PLF / CLYX-SP3 / CLYX-SP9 / CLYX-ALC					
	2D	3D	5D	7D	9D	11D
Material do Corpo <i>Body Material / Cuerpo Material</i>	Alumínio Fundido					
Material do Visor <i>Display Material / Material de Exhibición</i>	Vidro temperado de 4mm / policarbonato 4mm					
Entrada Rosqueada <i>Threaded Entry / Entrada Roscada</i>	Padrão 3/4" NPT - Opcioal: 3/4" BSP ou M25 - Modelos para poste com entrada padrão: 1.1/2" BSP, opcional: 1.1/2" NPT					



Medidas <i>Measures / Medidas</i>	CLYX-PDT	CLYX-A30	CLYX-A90	CLYX-PLF	CLYX-SP3	CLYX-SP9	CLYX-ALC
Tamanho Corpo 1 <i>Body Size 1 / Tamaño del Cuerpo 1</i>	228x156mm	363x231mm	342x214mm	228x116mm	350x205mm	340x192mm	236x218mm
Tamanho Corpo 2 <i>Body Size 2 / Tamaño del Cuerpo 2</i>	227x207mm	401x284mm	355x266mm	274x169mm	388x259mm	352x243mm	320x278mm
Peso Corpo 1 <i>Body Weight 1 / Peso Cuerpo 1</i>	2,8Kg	3,5Kg	3,5Kg	2,8Kg	3,8Kg	3,8Kg	3,1Kg
Peso Corpo 2 <i>Body Weight 2 / Peso Cuerpo 2</i>	4,9Kg	5,6Kg	5,6Kg	4,9Kg	5,9Kg	5,9Kg	5,2Kg
Instalação <i>Installation / Instalación</i>	Fixado Pendente <i>Fixed Pending / Pendiente Fija</i>	Arandela 30° <i>Sconce 30° / Candelabro de Pared 30°</i>	Arandela 90° <i>Sconce 90° / Candelabro de Pared 90°</i>	Plafonier <i>Ceiling Light / Lámpara de Techo</i>	Poste 30° <i>Pole 30° / Poste 30°</i>	Poste 90° <i>Pole 90° / Poste 90°</i>	Alça <i>Strap / Bandolera</i>

Codificação Codification / Codificación

CLYX

Linha <i>Line / Línea</i>
CLYX

PDT

Modelo <i>Model / Modelo</i>	
PDT	Pendente
A30	Arandela 30°
A90	Arandela 90°
PLF	Plafonier
SP3	Suporte para poste 30°
SP9	Suporte para poste 90°
ALC	Alça

3D

Potência <i>Power / Potencia</i>	
2D	20W
3D	30W
5D	45W
7D	60W
9D	80W
11D	90W

K50

Temp. de Cor <i>Color Temp. / Temp. del Color</i>	
K50	5000K

CF90

Tipo de Lente <i>Lens Type / Tipo de Lente</i>	
padrão	115°
CF60	60°
CF90	90°

TA

Acessórios sob Encomenda <i>Custom Accessories / Accesorios Personalizados</i>	
TA	Terminal olho de segurança para ancoragem <i>Anchor Safety Eye Terminal / Terminal de Ojo de Seguridad de Ancla</i>
CR	Pintura Especial Conexrevest <i>Special Painting Conexrevest / Pintura Especial Conexrevest</i>
DP	Difusor em Policarbonato <i>Polycarbonate Diffuser / Difusor de Policarbonato</i>

VD12

Tensão de Trabalho <i>Working Voltage / Tensión de Trabajo</i>	
padrão	220/240VAC
VD12	12VCC
VD24	24VCC
VCC	90-305VAC / 100-280VCC

Prensa Cabo Alumínio Ex* <i>Ex Aluminum Cable Gland / Prensa de Cable de Aluminio Ex</i>	
PC12N	Prensa cabo 1/2" <i>1/2" cable gland / Prensacables de 1/2"</i>
PC34N	Prensa cabo 3/4" <i>3/4" cable gland / Prensacables de 3/4"</i>
PCM25	Prensa cabo M25 <i>M25 cable gland / Prensacables de M25</i>

*Prensa cabos disponíveis sob encomenda

Cable glands available on request / Prensastopas disponibles bajo pedido

Para a rosca BSP, substituir a letra N por B - Exemplo: PC12B = Prensa cabo 1/2" BSP

For the BSP thread, replace the letter N with B - Example: PC12B = 1/2" BSP cable gland / Para la rosca BSP, reemplaza la letra N por B - Ejemplo: PC12B = prensastopas 1/2" BSP

Consulte-nos: luminárias com alimentação em tensão especial (12VCC / 24VCC / 90-305VAC / 100-280VCC)

Consult us: luminaires with special voltage supply / Consultémos: luminarias con tensión de alimentación especial