

Projektor LED Modular

Modular LED Floodlight / Reflector LED Modular

Linha Indaiá · CLF-MP(F)

Indaiá Line / Línea Indaiá



Sistema modular que facilita a manutenção e um conjunto de LED e lente que proporcionam alta uniformidade luminosa e excelente distribuição da luz.

Modular system that facilitates maintenance and a set of LEDs and lenses that provide high luminous uniformity and excellent light distribution.

Sistema modular que facilita el mantenimiento y un conjunto de LEDs y lentes que proporcionan una alta uniformidad luminosa y una excelente distribución lumínica.



Driver Dimerizável 0-10V (opcional)

Dimmable Driver 0-10V (optional) / Controlador Regulable 0-10V (opcional)



Protetor de Surto 10kA incluso

10kA Surge Protector included / Protector de sobretensión 10kA incluido



Eficiência luminosa de até 170 lm/w

Luminous efficiency up to 170 lm/w / Eficiência luminosa hasta 170 lm/w

Aplicações Highlights / Destacar



Indústrias
Industries / Industrias



Aeroportos
Airports / Aeropuertos



Fachadas
Fronts / Fachadas



Condomínios
Condominiums / Condominios



Pedágios
Tolls / Peajes



Estacionamentos
Parking Lots / Estacionamientos



Quadras e Estádios
Canchas y Estádios

Ambientes Internos e Externos
Indoor and Outdoor Environments / Ambientes interiores y exteriores

Ambientes Industriais
Industrial Environments / Ambientes Industriales

Produto não recomendado para áreas agressivas/salinas
Product not Recommended for Aggressive - Saline Areas / Producto no Recomendado para Áreas Agressivas - Salinas



Sistema modular com fixação versátil

Modular system with versatile fixing / Sistema modular con fijación versátil.

Normas Standards / Normas

NBR IEC - 60598-1 / NBR IEC - 60529 / NBR IEC - 62031 / IES LM 80-08 / IES TM 21



1 Módulo
50W



2 Módulos
100W



3 Módulos
150W

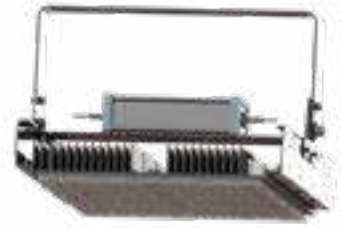

4 Módulos
200W

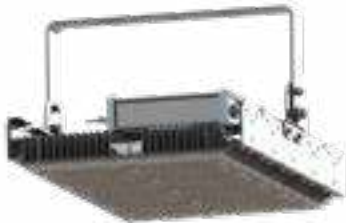

5 Módulos
250W



6 Módulos
300W



4/4 Módulos
400W

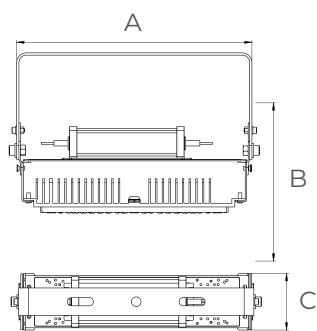

1 Módulo

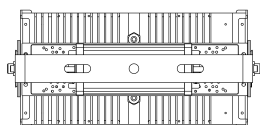

2 Módulos

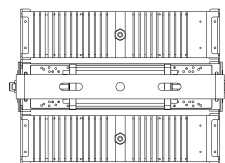

3 Módulos

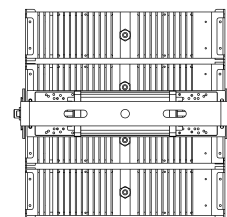

4 Módulos

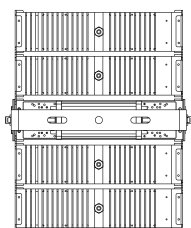
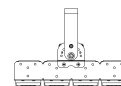
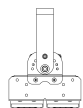

5 Módulos

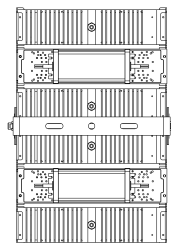

6 Módulos



4/4 Módulos

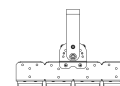
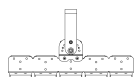

Curvas Fotométricas *Photometric Curves / Curvas Fotométricas*

60°

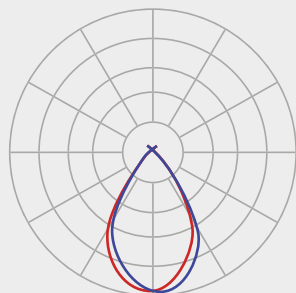

90°

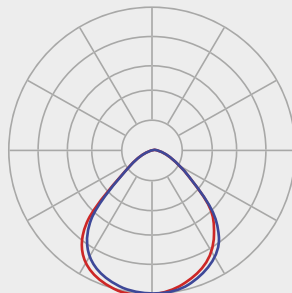

Informações Técnicas *Technical Information / Informaciones Técnicas*

Características Gerais <i>General Features / Características Generales</i>	CLF-MP50F	CLF-MP100F	CLF-MP150F	CLF-MP200F	CLF-MP250F	CLF-MP300F	CLF-MP400F
Consumo do Sistema <i>System Consumption / Consumo del Sistema</i>	50W (±10%)	100W (±10%)	150W (±10%)	200W (±10%)	250W (±10%)	300W (±10%)	400W (±10%)
Tensão de trabalho padrão <i>Standard working voltage / Voltaje de trabajo estándar</i>	120-240 VAC / 277 VAC / 90-230 VCC / 280 VCC						
Frequência de operação <i>Operation Frequency / Frecuencia de Operación</i>	50/60Hz em VAC						
Fator de Potência (à plena carga) <i>Power Factor (at full load) / Factor de Potencia (a plena carga)</i>	>0.98 @ 115VAC, >0.95@230VAC, >0,93@277VAC						
Condição de Utilização <i>Conditions of Use / Condiciones de Uso</i>	Altitude: 1500m / Temperatura Média do ar: +40°C / Temperatura do ar ambiente: -40°C ~ +60°C / Umidade relativa do ar: até 100%						
Tipo de Proteção elétrica/eletrônica <i>Protection type electrical - electronic / Tipo de protección eléctrica - electrónica</i>	Curto-Circuito, Sobretensão, Sobrecorrente, Sobreaquecimento						
Grau de Proteção <i>Protection Grade / Grado de Protección</i>	IP67						
Grau de Impacto <i>Impact Grade / Grado de Impacto</i>	IK08						
Protetor de Surto <i>Surge Protector / Protetor contra Sobretensiones</i>	UC: 275V - 10Ka (8/20) - 1,0 KV - Categoria C						

Características Fotométricas e Óticas <i>General and Photometric Features / Características Generales y Fotométricas</i>	CLF-MP50F	CLF-MP100F	CLF-MP150F	CLF-MP200F	CLF-MP250F	CLF-MP300F	CLF-MP400F
Índice de Reprodução de Cores <i>Color Rendering Index / Índice de Reproducción de Color</i>	>70						
Temperatura de Cor Padrão <i>Standard Color Temperature / Temperatura de Color Estándar</i>	5 000K (±275K)						
Ângulo do fecho padrão <i>Beam Opening Angle / Ángulo de Apertura del Haz</i>	90°			60°			
Fator de Depreciação Luminosa <i>Light Depreciation Factor / Factor de Depreciación Leve</i>	até 10% para 60 000h @ 1,0A e Tj=65°C						
Vida Útil <i>Estimated Service Life / Vida Estimada</i>	100 000h (L70 B50)						
Fluxo Luminoso da Luminária (@Tj65°C) <i>Luminous Flux of the Fixture / Corrientes de luz de la luminaria</i>	8 500 lm (±10%)	17 000 lm (±10%)	25 500 lm (±10%)	34 000 lm (±10%)	42 500 lm (±10%)	51 000 lm (±10%)	68 000 lm (±10%)
Eficiência da Luminária (@Tj65°C) <i>Luminaire Efficiency / Eficiencia luminaria</i>	170 lm/w (±10%)	170 lm/w (±10%)	170 lm/w (±10%)	170 lm/w (±10%)	170 lm/w (±10%)	170 lm/w (±10%)	170 lm/w (±10%)



Características Construtivas <i>Constructive Features / Características Constructivas</i>	CLF-MP50F	CLF-MP100F	CLF-MP150F	CLF-MP200F	CLF-MP250F	CLF-MP300F	CLF-MP400F
Quantidade de Módulos <i>Number of Modules / Numero de Modulos</i>	1	2	3	4	5	6	8
Material do Corpo <i>Body Material / Cuerpo Material</i>	Alumínio						
Material do Dissipador <i>Heatsink Material / Material del Dissipador de Calor</i>	Alumínio Extrudado 6063						
Material da Lente <i>Lens Material / Material de la Lente</i>	PPMA						
Instalação <i>Installation / Instalación</i>	Fixado através de parafusos e suporte tipo alça						
Peso <i>Weight / Peso</i>	2,1 kg	2,9 kg	3,7 kg	4,5 kg	5,3 kg	7,2 kg	9,1 kg
Medidas (AxBxC) <i>Measures (AxBxC) / Medidas (AxBxC)</i>	316 x 215 x 76mm	316 x 215 x 156mm	316 x 215 x 236mm	316 x 215 x 316mm	316 x 215 x 396mm	316 x 215 x 476mm	632 X 316 X 215mm

Codificação Codification / Codificación

CLF

Linha
Line / Línea

CLF

MP50F

Modelo
Model / Modelo

MP50F	50W
MP100F	100W
MP150F	150W
MP200F	200W
MP250F	250W
MP300F	300W
MP400F	400W

K50

Temp. de Cor
Color Temp. / Temp. del Color

K50 5000K

CF60

Tipo de Lente*
Lens Type / Tipo de Lente**

CF60	60°
CF90	90°

DM

Dimerizável
Dimmable / Regulable

SE

Acessórios

Accessories / Accesorios

SE	Suporte para Eletrocalha <i>Cable Tray Support / Soporte de Bandeja de Cables</i>
ST	Suporte para Tubo** <i>Tube Support** / Soporte para Tubo**</i>
PU	Plug 2P+T Universal <i>Universal 2P+T Plug / Enchufe Universal 2P+T</i>
TA	Terminal de Ancoragem <i>Anchorage Terminal / Terminal de Anchorage</i>

*Lente de 90°: de 50 a 150W - Lente de 60°: de 200 a 400W

**90° lens: from 50 to 150W - 60° lens: from 200 to 400W / *Lente 90°: de 50 a 150W - Lente 60°: de 200 a 400W*

Consulte-nos: luminárias com alimentação em tensão especial
(110/220V / 12V / 24V / 125VCC)

Consult us: luminaires with special voltage supply / Consultenos: luminarias con tensión de alimentación especial

****Medidas de Tubos**

***Tube Measurements / **Medidas del tubo*

padrão	Tubo 3/4" polegada
ST1	Tubo 1" polegada
ST112	Tubo 1.1/2" polegada
ST2	Tubo 2" polegada